



Signal Generator

R&S[®] SMC100A

1411.4002K02



Dear Customer,

throughout this manual, the Signal Generator R&S® SMC100A is abbreviated as R&S SMC100A.

The firmware of the instrument makes use of the operating system LINUX® and other valuable open source software packages. The most important of them are listed below together with their corresponding open source license. The verbatim license texts are provided on the user documentation CD-ROM (included in delivery).

Package	Link	License
LINUX® Kernel	http://www.linux.org/	GPL 2
glibc	http://www.gnu.org/software/libc/	LGPL
busybox	http://www.busybox.net/	GPL 2
OpenSSL	http://www.openssl.org/	OpenSSL / SSLeay
XFree86	http://www.xfree86.org/	XFree86
Xitami	http://www.xitami.com	NetSnmp-5.0.8
PHP	http://www.php.net	2.5b6
OpenSSL	http://www.openssl.org	BSD
BOOST Library	http://www.boost.org	Artistic
zlib	http://www.zlib.net	Boost Software, v.1
PC/SC-Lite	http://www.linuxnet.com/	ACE_TAO

The OpenSSL Project for use in the OpenSSL Toolkit (<http://www.openssl.org/>), includes cryptographic software written by Eric Young (eay@cryptsoft.com) and software written by Tim Hudson (tjh@cryptsoft.com).

LINUX® is a trademark of Linus Torvalds.

Rohde & Schwarz would like to thank the open source community for their valuable contribution to embedded computing.

R&S® is a registered trademark of Rohde & Schwarz GmbH & Co. KG. Trade names are trademarks of the owners.

Chapter Overview

Index

Safety Instructions

Customer Information Regarding Product Disposal

Certificate of Quality

Customer Support

Procedure in Case of Service and Ordering of Spare Parts

Contents of Service Manual for the Signal Generator R&S SMC100A

Chapter 1: Performance Test

Chapter 2: Procedures after Module Replacement

Chapter 3: Repair

Chapter 4: Software Update / Installing Options

Chapter 5: Documents

Index

A

Adjustments	2.1
Amplitude modulation	
Test procedure	1.26, 1.31

B

Boot problems	
Troubleshooting	3.11

C

Check	
Rated characteristics	1.1
Check Front Panel	3.12

D

Debug Page	3.14
Documents	5.1

E

External level correction	2.3
---------------------------------	-----

F

Fan does not work	3.10
Firmware update	4.1
Frequency Error	3.27, 3.29
Fuses	3.34

I

Internal Adjustments	3.16
----------------------------	------

L

Level	
Test procedure	1.20

M

Measuring equipment	
Troubleshooting	3.7
Modulation	
Analog	
Test assembly	1.3
Modulation generator	
Test procedure	1.24
Module replacement	3.30
Modules overview	3.30
Motherboard	3.5

O

Option	
Installation	4.2
List	4.2
Output impedance	
Test assembly	1.5

P

Phase noise	
Test assembly	1.4
Power cables	5.2
Power Supply Module	3.5
Protection service functions	3.14
Pulse modulation	
Test procedure	1.38

R

Rated characteristics	
Checking	1.1
Test procedures	1.7
Reference frequency	
Test procedure	1.7
Replacement	
Module	3.30
Replacing Fuses	3.34
Residual	
AM	
Test assembly	1.4

S

Software update	4.1
Spectral purity	
Test procedure	1.10
Switch-on problems	3.9

T

Test assembly	1.3
Analog modulations	1.3
Output impedance	1.5
Residual AM	1.4
SSB phase noise	1.4
Test equipment	1.1
Test frequency (recommended)	1.6
Test Points	3.14
Test procedure	
Amplitude modulation	1.26, 1.31
Level	1.20
Modulation generator	1.24
Pulse modulation	1.38
Spectral purity	1.10
Test procedures	1.7
Troubleshooting	
Problems with booting	3.11
Switch-on problems	3.9
Test points and debug page	3.14
Troubleshooting – Internal Adjustments	3.16

U

Unit cannot be switched on	3.9
Update of firmware	4.1
Update of software	4.1

Basic Safety Instructions

Always read through and comply with the following safety instructions!















All plants and locations of the Rohde & Schwarz group of companies make every effort to keep the safety standards of our products up to date and to offer our customers the highest possible degree of safety. Our products and the auxiliary equipment they require are designed, built and tested in accordance with the safety standards that apply in each case. Compliance with these standards is continuously monitored by our quality assurance system. The product described here has been designed, built and tested in accordance with the attached EC Certificate of Conformity and has left the manufacturer's plant in a condition fully complying with safety standards. To maintain this condition and to ensure safe operation, you must observe all instructions and warnings provided in this manual. If you have any questions regarding these safety instructions, the Rohde & Schwarz group of companies will be happy to answer them.

Furthermore, it is your responsibility to use the product in an appropriate manner. This product is designed for use solely in industrial and laboratory environments or, if expressly permitted, also in the field and must not be used in any way that may cause personal injury or property damage. You are responsible if the product is used for any intention other than its designated purpose or in disregard of the manufacturer's instructions. The manufacturer shall assume no responsibility for such use of the product.

The product is used for its designated purpose if it is used in accordance with its product documentation and within its performance limits (see data sheet, documentation, the following safety instructions). Using the product requires technical skills and a basic knowledge of English. It is therefore essential that only skilled and specialized staff or thoroughly trained personnel with the required skills be allowed to use the product. If personal safety gear is required for using Rohde & Schwarz products, this will be indicated at the appropriate place in the product documentation. Keep the basic safety instructions and the product documentation in a safe place and pass them on to the subsequent users.

Observing the safety instructions will help prevent personal injury or damage of any kind caused by dangerous situations. Therefore, carefully read through and adhere to the following safety instructions before and when using the product. It is also absolutely essential to observe the additional safety instructions on personal safety, for example, that appear in relevant parts of the product documentation. In these safety instructions, the word "product" refers to all merchandise sold and distributed by the Rohde & Schwarz group of companies, including instruments, systems and all accessories.

Symbols and safety labels

							
Notice, general danger location Observe product documentation	Caution when handling heavy equipment	Danger of electric shock	Warning! Hot surface	PE terminal	Ground	Ground terminal	Be careful when handling electrostatic sensitive devices
							
ON/OFF supply voltage	Standby indication	Direct current (DC)	Alternating current (AC)	Direct/alternating current (DC/AC)	Device fully protected by double (reinforced) insulation		

Tags and their meaning

The following signal words are used in the product documentation in order to warn the reader about risks and dangers.



indicates a hazardous situation which, if not avoided, will result in death or serious injury.



indicates a hazardous situation which, if not avoided, could result in death or serious injury.



indicates a hazardous situation which, if not avoided, could result in minor or moderate injury.



indicates the possibility of incorrect operation which can result in damage to the product.

In the product documentation, the word ATTENTION is used synonymously.

These tags are in accordance with the standard definition for civil applications in the European Economic Area. Definitions that deviate from the standard definition may also exist in other economic areas or military applications. It is therefore essential to make sure that the tags described here are always used only in connection with the related product documentation and the related product. The use of tags in connection with unrelated products or documentation can result in misinterpretation and in personal injury or material damage.

Operating states and operating positions

The product may be operated only under the operating conditions and in the positions specified by the manufacturer, without the product's ventilation being obstructed. If the manufacturer's specifications are not observed, this can result in electric shock, fire and/or serious personal injury or death. Applicable local or national safety regulations and rules for the prevention of accidents must be observed in all work performed.

1. Unless otherwise specified, the following requirements apply to Rohde & Schwarz products: predefined operating position is always with the housing floor facing down, IP protection 2X, pollution severity 2, overvoltage category 2, use only indoors, max. operating altitude 2000 m above sea level, max. transport altitude 4500 m above sea level. A tolerance of $\pm 10\%$ shall apply to the nominal voltage and $\pm 5\%$ to the nominal frequency.
2. Do not place the product on surfaces, vehicles, cabinets or tables that for reasons of weight or stability are unsuitable for this purpose. Always follow the manufacturer's installation instructions when installing the product and fastening it to objects or structures (e.g. walls and shelves). An installation that is not carried out as described in the product documentation could result in personal injury or death.
3. Do not place the product on heat-generating devices such as radiators or fan heaters. The ambient temperature must not exceed the maximum temperature specified in the product documentation or in the data sheet. Product overheating can cause electric shock, fire and/or serious personal injury or death.

Electrical safety

If the information on electrical safety is not observed either at all to the extent necessary, electric shock, fire and/or serious personal injury or death may occur.

1. Prior to switching on the product, always ensure that the nominal voltage setting on the product matches the nominal voltage of the AC supply network. If a different voltage is to be set, the power fuse of the product may have to be changed accordingly.
2. In the case of products of safety class I with movable power cord and connector, operation is permitted only on sockets with an earthing contact and protective earth connection.
3. Intentionally breaking the protective earth connection either in the feed line or in the product itself is not permitted. Doing so can result in the danger of an electric shock from the product. If extension cords or connector strips are implemented, they must be checked on a regular basis to ensure that they are safe to use.
4. If the product does not have a power switch for disconnection from the AC supply network, the plug of the connecting cable is regarded as the disconnecting device. In such cases, always ensure that the power plug is easily reachable and accessible at all times (corresponding to the length of connecting cable, approx. 2 m). Functional or electronic switches are not suitable for providing disconnection from the AC supply network. If products without power switches are integrated into racks or systems, a disconnecting device must be provided at the system level.
5. Never use the product if the power cable is damaged. Check the power cable on a regular basis to ensure that it is in proper operating condition. By taking appropriate safety measures and carefully laying the power cable, you can ensure that the cable will not be damaged and that no one can be hurt by, for example, tripping over the cable or suffering an electric shock.
6. The product may be operated only from TN/TT supply networks fused with max. 16 A (higher fuse only after consulting with the Rohde & Schwarz group of companies).
7. Do not insert the plug into sockets that are dusty or dirty. Insert the plug firmly and all the way into the socket. Otherwise, sparks that result in fire and/or injuries may occur.
8. Do not overload any sockets, extension cords or connector strips; doing so can cause fire or electric shocks.
9. For measurements in circuits with voltages $V_{\text{rms}} > 30 \text{ V}$, suitable measures (e.g. appropriate measuring equipment, fusing, current limiting, electrical separation, insulation) should be taken to avoid any hazards.
10. Ensure that the connections with information technology equipment, e.g. PCs or other industrial computers, comply with the IEC60950-1/EN60950-1 or IEC61010-1/EN 61010-1 standards that apply in each case.
11. Unless expressly permitted, never remove the cover or any part of the housing while the product is in operation. Doing so will expose circuits and components and can lead to injuries, fire or damage to the product.
12. If a product is to be permanently installed, the connection between the PE terminal on site and the product's PE conductor must be made first before any other connection is made. The product may be installed and connected only by a licensed electrician.
13. For permanently installed equipment without built-in fuses, circuit breakers or similar protective devices, the supply circuit must be fused in such a way that anyone who has access to the product, as well as the product itself, is adequately protected from injury or damage.

14. Use suitable overvoltage protection to ensure that no overvoltage (such as that caused by a bolt of lightning) can reach the product. Otherwise, the person operating the product will be exposed to the danger of an electric shock.
15. Any object that is not designed to be placed in the openings of the housing must not be used for this purpose. Doing so can cause short circuits inside the product and/or electric shocks, fire or injuries.
16. Unless specified otherwise, products are not liquid-proof (see also section "Operating states and operating positions", item 1. Therefore, the equipment must be protected against penetration by liquids. If the necessary precautions are not taken, the user may suffer electric shock or the product itself may be damaged, which can also lead to personal injury.
17. Never use the product under conditions in which condensation has formed or can form in or on the product, e.g. if the product has been moved from a cold to a warm environment. Penetration by water increases the risk of electric shock.
18. Prior to cleaning the product, disconnect it completely from the power supply (e.g. AC supply network or battery). Use a soft, non-linting cloth to clean the product. Never use chemical cleaning agents such as alcohol, acetone or diluents for cellulose lacquers.

Operation

1. Operating the products requires special training and intense concentration. Make sure that persons who use the products are physically, mentally and emotionally fit enough to do so; otherwise, injuries or material damage may occur. It is the responsibility of the employer/operator to select suitable personnel for operating the products.
2. Before you move or transport the product, read and observe the section titled "Transport".
3. As with all industrially manufactured goods, the use of substances that induce an allergic reaction (allergens) such as nickel cannot be generally excluded. If you develop an allergic reaction (such as a skin rash, frequent sneezing, red eyes or respiratory difficulties) when using a Rohde & Schwarz product, consult a physician immediately to determine the cause and to prevent health problems or stress.
4. Before you start processing the product mechanically and/or thermally, or before you take it apart, be sure to read and pay special attention to the section titled "Waste disposal", item 1.
5. Depending on the function, certain products such as RF radio equipment can produce an elevated level of electromagnetic radiation. Considering that unborn babies require increased protection, pregnant women must be protected by appropriate measures. Persons with pacemakers may also be exposed to risks from electromagnetic radiation. The employer/operator must evaluate workplaces where there is a special risk of exposure to radiation and, if necessary, take measures to avert the potential danger.
6. Should a fire occur, the product may release hazardous substances (gases, fluids, etc.) that can cause health problems. Therefore, suitable measures must be taken, e.g. protective masks and protective clothing must be worn.
7. If a laser product (e.g. a CD/DVD drive) is integrated into a Rohde & Schwarz product, absolutely no other settings or functions may be used as described in the product documentation. The objective is to prevent personal injury (e.g. due to laser beams).

Repair and service

1. The product may be opened only by authorized, specially trained personnel. Before any work is performed on the product or before the product is opened, it must be disconnected from the AC supply network. Otherwise, personnel will be exposed to the risk of an electric shock.
2. Adjustments, replacement of parts, maintenance and repair may be performed only by electrical experts authorized by Rohde & Schwarz. Only original parts may be used for replacing parts relevant to safety (e.g. power switches, power transformers, fuses). A safety test must always be performed after parts relevant to safety have been replaced (visual inspection, PE conductor test, insulation resistance measurement, leakage current measurement, functional test). This helps ensure the continued safety of the product.

Batteries and rechargeable batteries/cells

If the information regarding batteries and rechargeable batteries/cells is not observed either at all or to the extent necessary, product users may be exposed to the risk of explosions, fire and/or serious personal injury, and, in some cases, death. Batteries and rechargeable batteries with alkaline electrolytes (e.g. lithium cells) must be handled in accordance with the EN 62133 standard.

1. Cells must not be taken apart or crushed.
2. Cells or batteries must not be exposed to heat or fire. Storage in direct sunlight must be avoided. Keep cells and batteries clean and dry. Clean soiled connectors using a dry, clean cloth.
3. Cells or batteries must not be short-circuited. Cells or batteries must not be stored in a box or in a drawer where they can short-circuit each other, or where they can be short-circuited by other conductive materials. Cells and batteries must not be removed from their original packaging until they are ready to be used.
4. Keep cells and batteries out of the hands of children. If a cell or a battery has been swallowed, seek medical aid immediately.
5. Cells and batteries must not be exposed to any mechanical shocks that are stronger than permitted.
6. If a cell develops a leak, the fluid must not be allowed to come into contact with the skin or eyes. If contact occurs, wash the affected area with plenty of water and seek medical aid.
7. Improperly replacing or charging cells or batteries that contain alkaline electrolytes (e.g. lithium cells) can cause explosions. Replace cells or batteries only with the matching Rohde & Schwarz type (see parts list) in order to ensure the safety of the product.
8. Cells and batteries must be recycled and kept separate from residual waste. Rechargeable batteries and normal batteries that contain lead, mercury or cadmium are hazardous waste. Observe the national regulations regarding waste disposal and recycling.

Transport

1. The product may be very heavy. Therefore, the product must be handled with care. In some cases, the user may require a suitable means of lifting or moving the product (e.g. with a lift-truck) to avoid back or other physical injuries.

2. Handles on the products are designed exclusively to enable personnel to transport the product. It is therefore not permissible to use handles to fasten the product to or on transport equipment such as cranes, fork lifts, wagons, etc. The user is responsible for securely fastening the products to or on the means of transport or lifting. Observe the safety regulations of the manufacturer of the means of transport or lifting. Noncompliance can result in personal injury or material damage.
3. If you use the product in a vehicle, it is the sole responsibility of the driver to drive the vehicle safely and properly. The manufacturer assumes no responsibility for accidents or collisions. Never use the product in a moving vehicle if doing so could distract the driver of the vehicle. Adequately secure the product in the vehicle to prevent injuries or other damage in the event of an accident.

Waste disposal

1. If products or their components are mechanically and/or thermally processed in a manner that goes beyond their intended use, hazardous substances (heavy-metal dust such as lead, beryllium, nickel) may be released. For this reason, the product may only be disassembled by specially trained personnel. Improper disassembly may be hazardous to your health. National waste disposal regulations must be observed.
2. If handling the product releases hazardous substances or fuels that must be disposed of in a special way, e.g. coolants or engine oils that must be replenished regularly, the safety instructions of the manufacturer of the hazardous substances or fuels and the applicable regional waste disposal regulations must be observed. Also observe the relevant safety instructions in the product documentation. The improper disposal of hazardous substances or fuels can cause health problems and lead to environmental damage.

Informaciones elementales de seguridad

Es imprescindible leer y observar las siguientes instrucciones e informaciones de seguridad!









El principio del grupo de empresas Rohde & Schwarz consiste en tener nuestros productos siempre al día con los estándares de seguridad y de ofrecer a nuestros clientes el máximo grado de seguridad. Nuestros productos y todos los equipos adicionales son siempre fabricados y examinados según las normas de seguridad vigentes. Nuestro sistema de garantía de calidad controla constantemente que sean cumplidas estas normas. El presente producto ha sido fabricado y examinado según el certificado de conformidad adjunto de la UE y ha salido de nuestra planta en estado impecable según los estándares técnicos de seguridad. Para poder preservar este estado y garantizar un funcionamiento libre de peligros, el usuario deberá atenerse a todas las indicaciones, informaciones de seguridad y notas de alerta. El grupo de empresas Rohde & Schwarz está siempre a su disposición en caso de que tengan preguntas referentes a estas informaciones de seguridad.







Además queda en la responsabilidad del usuario utilizar el producto en la forma debida. Este producto está destinado exclusivamente al uso en la industria y el laboratorio o, si ha sido expresamente autorizado, para aplicaciones de campo y de ninguna manera deberá ser utilizado de modo que alguna persona/cosa pueda sufrir daño. El uso del producto fuera de sus fines definidos o sin tener en cuenta las instrucciones del fabricante queda en la responsabilidad del usuario. El fabricante no se hace en ninguna forma responsable de consecuencias a causa del mal uso del producto.

Se parte del uso correcto del producto para los fines definidos si el producto es utilizado conforme a las indicaciones de la correspondiente documentación del producto y dentro del margen de rendimiento definido (ver hoja de datos, documentación, informaciones de seguridad que siguen). El uso del producto hace necesarios conocimientos técnicos y ciertos conocimientos del idioma inglés. Por eso se debe tener en cuenta que el producto solo pueda ser operado por personal especializado o personas instruidas en profundidad con las capacidades correspondientes. Si fuera necesaria indumentaria de seguridad para el uso de productos de Rohde & Schwarz, encontraría la información debida en la documentación del producto en el capítulo correspondiente. Guarde bien las informaciones de seguridad elementales, así como la documentación del producto, y entréguelas a usuarios posteriores.

Tener en cuenta las informaciones de seguridad sirve para evitar en lo posible lesiones o daños por peligros de toda clase. Por eso es imprescindible leer detalladamente y comprender por completo las siguientes informaciones de seguridad antes de usar el producto, y respetarlas durante el uso del producto. Deberán tenerse en cuenta todas las demás informaciones de seguridad, como p. ej. las referentes a la protección de personas, que encontrarán en el capítulo correspondiente de la documentación del producto y que también son de obligado cumplimiento. En las presentes informaciones de seguridad se recogen todos los objetos que distribuye el grupo de empresas Rohde & Schwarz bajo la denominación de "producto", entre ellos también aparatos, instalaciones así como toda clase de accesorios.

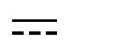
Símbolos y definiciones de seguridad

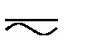
							
Aviso: punto de peligro general Observar la documentación del producto	Atención en el manejo de dispositivos de peso elevado	Peligro de choque eléctrico	Advertencia: superficie caliente	Conexión a conductor de protección	Conexión a tierra	Conexión a masa	Aviso: Cuidado en el manejo de dispositivos sensibles a la electrostática (ESD)

					
Tensión de alimentación de PUESTA EN MARCHA / PARADA	Indicación de estado de espera (Standby)	Corriente continua (DC)	Corriente alterna (AC)	Corriente continua / Corriente alterna (DC/AC)	El aparato está protegido en su totalidad por un aislamiento doble (reforzado)

Palabras de señal y su significado

En la documentación del producto se utilizan las siguientes palabras de señal con el fin de advertir contra riesgos y peligros.



PELIGRO identifica un peligro inminente con riesgo elevado que provocará muerte o lesiones graves si no se evita.



ADVERTENCIA identifica un posible peligro con riesgo medio de provocar muerte o lesiones (graves) si no se evita.



ATENCIÓN identifica un peligro con riesgo reducido de provocar lesiones leves o moderadas si no se evita.



AVISO indica la posibilidad de utilizar mal el producto y, como consecuencia, dañarlo.

En la documentación del producto se emplea de forma sinónima el término CUIDADO.

Las palabras de señal corresponden a la definición habitual para aplicaciones civiles en el área económica europea. Pueden existir definiciones diferentes a esta definición en otras áreas económicas o en aplicaciones militares. Por eso se deberá tener en cuenta que las palabras de señal aquí descritas sean utilizadas siempre solamente en combinación con la correspondiente documentación del producto y solamente en combinación con el producto correspondiente. La utilización de las palabras de señal en combinación con productos o documentaciones que no les correspondan puede llevar a interpretaciones equivocadas y tener por consecuencia daños en personas u objetos.

Estados operativos y posiciones de funcionamiento

El producto solamente debe ser utilizado según lo indicado por el fabricante respecto a los estados operativos y posiciones de funcionamiento sin que se obstruya la ventilación. Si no se siguen las indicaciones del fabricante, pueden producirse choques eléctricos, incendios y/o lesiones graves con posible consecuencia de muerte. En todos los trabajos deberán ser tenidas en cuenta las normas nacionales y locales de seguridad del trabajo y de prevención de accidentes.

1. Si no se convino de otra manera, es para los productos Rohde & Schwarz válido lo que sigue: como posición de funcionamiento se define por principio la posición con el suelo de la caja para abajo, modo de protección IP 2X, grado de suciedad 2, categoría de sobrecarga eléctrica 2, uso solamente en estancias interiores, utilización hasta 2000 m sobre el nivel del mar, transporte hasta 4500 m sobre el nivel del mar. Se aplicará una tolerancia de $\pm 10\%$ sobre el voltaje nominal y de $\pm 5\%$ sobre la frecuencia nominal.
2. No sitúe el producto encima de superficies, vehículos, estantes o mesas, que por sus características de peso o de estabilidad no sean aptos para él. Siga siempre las instrucciones de instalación del fabricante cuando instale y asegure el producto en objetos o estructuras (p. ej. paredes y estantes). Si se realiza la instalación de modo distinto al indicado en la documentación del producto, pueden causarse lesiones o incluso la muerte.
3. No ponga el producto sobre aparatos que generen calor (p. ej. radiadores o calefactores). La temperatura ambiente no debe superar la temperatura máxima especificada en la documentación del producto o en la hoja de datos. En caso de sobrecalentamiento del producto, pueden producirse choques eléctricos, incendios y/o lesiones graves con posible consecuencia de muerte.

Seguridad eléctrica

Si no se siguen (o se siguen de modo insuficiente) las indicaciones del fabricante en cuanto a seguridad eléctrica, pueden producirse choques eléctricos, incendios y/o lesiones graves con posible consecuencia de muerte.

1. Antes de la puesta en marcha del producto se deberá comprobar siempre que la tensión preseleccionada en el producto coincida con la de la red de alimentación eléctrica. Si es necesario modificar el ajuste de tensión, también se deberán cambiar en caso dado los fusibles correspondientes del producto.
2. Los productos de la clase de protección I con alimentación móvil y enchufe individual solamente podrán enchufarse a tomas de corriente con contacto de seguridad y con conductor de protección conectado.
3. Queda prohibida la interrupción intencionada del conductor de protección, tanto en la toma de corriente como en el mismo producto. La interrupción puede tener como consecuencia el riesgo de que el producto sea fuente de choques eléctricos. Si se utilizan cables alargadores o regletas de enchufe, deberá garantizarse la realización de un examen regular de los mismos en cuanto a su estado técnico de seguridad.
4. Si el producto no está equipado con un interruptor para desconectarlo de la red, se deberá considerar el enchufe del cable de conexión como interruptor. En estos casos se deberá asegurar que el enchufe siempre sea de fácil acceso (de acuerdo con la longitud del cable de conexión, aproximadamente 2 m). Los interruptores de función o electrónicos no son aptos para el corte de la red eléctrica. Si los productos sin interruptor están integrados en bastidores o instalaciones, se deberá colocar el interruptor en el nivel de la instalación.
5. No utilice nunca el producto si está dañado el cable de conexión a red. Compruebe regularmente el correcto estado de los cables de conexión a red. Asegúrese, mediante las medidas de protección y de instalación adecuadas, de que el cable de conexión a red no pueda ser dañado o de que nadie pueda ser dañado por él, p. ej. al tropezar o por un choque eléctrico.
6. Solamente está permitido el funcionamiento en redes de alimentación TN/TT aseguradas con fusibles de 16 A como máximo (utilización de fusibles de mayor amperaje solo previa consulta con el grupo de empresas Rohde & Schwarz).
7. Nunca conecte el enchufe en tomas de corriente sucias o llenas de polvo. Introduzca el enchufe por completo y fuertemente en la toma de corriente. La no observación de estas medidas puede provocar chispas, fuego y/o lesiones.
8. No sobrecargue las tomas de corriente, los cables alargadores o las regletas de enchufe ya que esto podría causar fuego o choques eléctricos.
9. En las mediciones en circuitos de corriente con una tensión $U_{\text{eff}} > 30 \text{ V}$ se deberán tomar las medidas apropiadas para impedir cualquier peligro (p. ej. medios de medición adecuados, seguros, limitación de tensión, corte protector, aislamiento etc.).
10. Para la conexión con dispositivos informáticos como un PC o un ordenador industrial, debe comprobarse que éstos cumplan los estándares IEC60950-1/EN60950-1 o IEC61010-1/EN 61010-1 válidos en cada caso.
11. A menos que esté permitido expresamente, no retire nunca la tapa ni componentes de la carcasa mientras el producto esté en servicio. Esto pone a descubierto los cables y componentes eléctricos y puede causar lesiones, fuego o daños en el producto.

12. Si un producto se instala en un lugar fijo, se deberá primero conectar el conductor de protección fijo con el conductor de protección del producto antes de hacer cualquier otra conexión. La instalación y la conexión deberán ser efectuadas por un electricista especializado.
13. En el caso de dispositivos fijos que no estén provistos de fusibles, interruptor automático ni otros mecanismos de seguridad similares, el circuito de alimentación debe estar protegido de modo que todas las personas que puedan acceder al producto, así como el producto mismo, estén a salvo de posibles daños.
14. Todo producto debe estar protegido contra sobretensión (debida p. ej. a una caída del rayo) mediante los correspondientes sistemas de protección. Si no, el personal que lo utilice quedará expuesto al peligro de choque eléctrico.
15. No debe introducirse en los orificios de la caja del aparato ningún objeto que no esté destinado a ello. Esto puede producir cortocircuitos en el producto y/o puede causar choques eléctricos, fuego o lesiones.
16. Salvo indicación contraria, los productos no están impermeabilizados (ver también el capítulo "Estados operativos y posiciones de funcionamiento", punto 1). Por eso es necesario tomar las medidas necesarias para evitar la entrada de líquidos. En caso contrario, existe peligro de choque eléctrico para el usuario o de daños en el producto, que también pueden redundar en peligro para las personas.
17. No utilice el producto en condiciones en las que pueda producirse o ya se hayan producido condensaciones sobre el producto o en el interior de éste, como p. ej. al desplazarlo de un lugar frío a otro caliente. La entrada de agua aumenta el riesgo de choque eléctrico.
18. Antes de la limpieza, desconecte por completo el producto de la alimentación de tensión (p. ej. red de alimentación o batería). Realice la limpieza de los aparatos con un paño suave, que no se deshilache. No utilice bajo ningún concepto productos de limpieza químicos como alcohol, acetona o diluyentes para lacas nitrocelulósicas.

Funcionamiento

1. El uso del producto requiere instrucciones especiales y una alta concentración durante el manejo. Debe asegurarse que las personas que manejen el producto estén a la altura de los requerimientos necesarios en cuanto a aptitudes físicas, psíquicas y emocionales, ya que de otra manera no se pueden excluir lesiones o daños de objetos. El empresario u operador es responsable de seleccionar el personal usuario apto para el manejo del producto.
2. Antes de desplazar o transportar el producto, lea y tenga en cuenta el capítulo "Transporte".
3. Como con todo producto de fabricación industrial no puede quedar excluida en general la posibilidad de que se produzcan alergias provocadas por algunos materiales empleados, los llamados alérgenos (p. ej. el níquel). Si durante el manejo de productos Rohde & Schwarz se producen reacciones alérgicas, como p. ej. irritaciones cutáneas, estornudos continuos, enrojecimiento de la conjuntiva o dificultades respiratorias, debe avisarse inmediatamente a un médico para investigar las causas y evitar cualquier molestia o daño a la salud.
4. Antes de la manipulación mecánica y/o térmica o el desmontaje del producto, debe tenerse en cuenta imprescindiblemente el capítulo "Eliminación", punto 1.

5. Ciertos productos, como p. ej. las instalaciones de radiocomunicación RF, pueden a causa de su función natural, emitir una radiación electromagnética aumentada. Deben tomarse todas las medidas necesarias para la protección de las mujeres embarazadas. También las personas con marcapasos pueden correr peligro a causa de la radiación electromagnética. El empresario/operador tiene la obligación de evaluar y señalar las áreas de trabajo en las que exista un riesgo elevado de exposición a radiaciones.
6. Tenga en cuenta que en caso de incendio pueden desprenderse del producto sustancias tóxicas (gases, líquidos etc.) que pueden generar daños a la salud. Por eso, en caso de incendio deben usarse medidas adecuadas, como p. ej. máscaras antigás e indumentaria de protección.
7. En caso de que un producto Rohde & Schwarz contenga un producto láser (p. ej. un lector de CD/DVD), no debe usarse ninguna otra configuración o función aparte de las descritas en la documentación del producto, a fin de evitar lesiones (p. ej. debidas a irradiación láser).

Reparación y mantenimiento

1. El producto solamente debe ser abierto por personal especializado con autorización para ello. Antes de manipular el producto o abrirlo, es obligatorio desconectarlo de la tensión de alimentación, para evitar toda posibilidad de choque eléctrico.
2. El ajuste, el cambio de partes, el mantenimiento y la reparación deberán ser efectuadas solamente por electricistas autorizados por Rohde & Schwarz. Si se reponen partes con importancia para los aspectos de seguridad (p. ej. el enchufe, los transformadores o los fusibles), solamente podrán ser sustituidos por partes originales. Después de cada cambio de partes relevantes para la seguridad deberá realizarse un control de seguridad (control a primera vista, control del conductor de protección, medición de resistencia de aislamiento, medición de la corriente de fuga, control de funcionamiento). Con esto queda garantizada la seguridad del producto.

Baterías y acumuladores o celdas

Si no se siguen (o se siguen de modo insuficiente) las indicaciones en cuanto a las baterías y acumuladores o celdas, pueden producirse explosiones, incendios y/o lesiones graves con posible consecuencia de muerte. El manejo de baterías y acumuladores con electrolitos alcalinos (p. ej. celdas de litio) debe seguir el estándar EN 62133.

1. No deben desmontarse, abrirse ni triturarse las celdas.
2. Las celdas o baterías no deben someterse a calor ni fuego. Debe evitarse el almacenamiento a la luz directa del sol. Las celdas y baterías deben mantenerse limpias y secas. Limpiar las conexiones sucias con un paño seco y limpio.
3. Las celdas o baterías no deben cortocircuitarse. Es peligroso almacenar las celdas o baterías en estuches o cajones en cuyo interior puedan cortocircuitarse por contacto recíproco o por contacto con otros materiales conductores. No deben extraerse las celdas o baterías de sus embalajes originales hasta el momento en que vayan a utilizarse.
4. Mantener baterías y celdas fuera del alcance de los niños. En caso de ingestión de una celda o batería, avisar inmediatamente a un médico.
5. Las celdas o baterías no deben someterse a impactos mecánicos fuertes indebidos.

6. En caso de falta de estanqueidad de una celda, el líquido vertido no debe entrar en contacto con la piel ni los ojos. Si se produce contacto, lavar con agua abundante la zona afectada y avisar a un médico.
7. En caso de cambio o recarga inadecuados, las celdas o baterías que contienen electrolitos alcalinos (p. ej. las celdas de litio) pueden explotar. Para garantizar la seguridad del producto, las celdas o baterías solo deben ser sustituidas por el tipo Rohde & Schwarz correspondiente (ver lista de recambios).
8. Las baterías y celdas deben reciclarse y no deben tirarse a la basura doméstica. Las baterías o acumuladores que contienen plomo, mercurio o cadmio deben tratarse como residuos especiales. Respete en esta relación las normas nacionales de eliminación y reciclaje.

Transporte

1. El producto puede tener un peso elevado. Por eso es necesario desplazarlo o transportarlo con precaución y, si es necesario, usando un sistema de elevación adecuado (p. ej. una carretilla elevadora), a fin de evitar lesiones en la espalda u otros daños personales.
2. Las asas instaladas en los productos sirven solamente de ayuda para el transporte del producto por personas. Por eso no está permitido utilizar las asas para la sujeción en o sobre medios de transporte como p. ej. grúas, carretillas elevadoras de horquilla, carros etc. Es responsabilidad suya fijar los productos de manera segura a los medios de transporte o elevación. Para evitar daños personales o daños en el producto, siga las instrucciones de seguridad del fabricante del medio de transporte o elevación utilizado.
3. Si se utiliza el producto dentro de un vehículo, recae de manera exclusiva en el conductor la responsabilidad de conducir el vehículo de manera segura y adecuada. El fabricante no asumirá ninguna responsabilidad por accidentes o colisiones. No utilice nunca el producto dentro de un vehículo en movimiento si esto pudiera distraer al conductor. Asegure el producto dentro del vehículo debidamente para evitar, en caso de un accidente, lesiones u otra clase de daños.

Eliminación

1. Si se trabaja de manera mecánica y/o térmica cualquier producto o componente más allá del funcionamiento previsto, pueden liberarse sustancias peligrosas (polvos con contenido de metales pesados como p. ej. plomo, berilio o níquel). Por eso el producto solo debe ser desmontado por personal especializado con formación adecuada. Un desmontaje inadecuado puede ocasionar daños para la salud. Se deben tener en cuenta las directivas nacionales referentes a la eliminación de residuos.
2. En caso de que durante el trato del producto se formen sustancias peligrosas o combustibles que deban tratarse como residuos especiales (p. ej. refrigerantes o aceites de motor con intervalos de cambio definidos), deben tenerse en cuenta las indicaciones de seguridad del fabricante de dichas sustancias y las normas regionales de eliminación de residuos. Tenga en cuenta también en caso necesario las indicaciones de seguridad especiales contenidas en la documentación del producto. La eliminación incorrecta de sustancias peligrosas o combustibles puede causar daños a la salud o daños al medio ambiente.

Kundeninformation zur Batterieverordnung (BattV)

Dieses Gerät enthält eine schadstoffhaltige Batterie. Diese darf nicht mit dem Hausmüll entsorgt werden.

Nach Ende der Lebensdauer darf die Entsorgung nur über eine Rohde&Schwarz-Kundendienststelle oder eine geeignete Sammelstelle erfolgen.

Safety Regulations for Batteries (according to BattV)

This equipment houses a battery containing harmful substances that must not be disposed of as normal household waste.

After its useful life, the battery may only be disposed of at a Rohde & Schwarz service center or at a suitable depot.

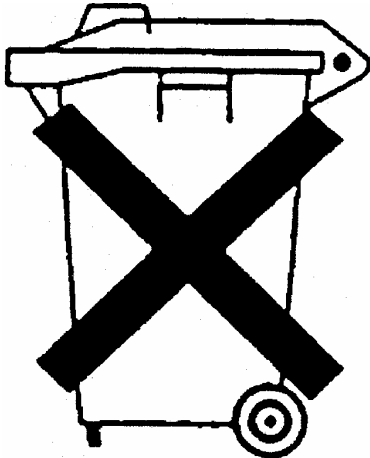

Normas de Seguridad para Baterías (Según BattV)

Este equipo lleva una batería que contiene sustancias perjudiciales, que no se debe desechar en los contenedores de basura domésticos.

Después de la vida útil, la batería sólo se podrá eliminar en un centro de servicio de Rohde & Schwarz o en un depósito apropiado.

Consignes de sécurité pour batteries (selon BattV)

Cet appareil est équipé d'une pile comprenant des substances nocives. Ne jamais la jeter dans une poubelle pour ordures ménagères.

Une pile usagée doit uniquement être éliminée par un centre de service client de Rohde & Schwarz ou peut être collectée pour être traitée spécialement comme déchets dangereux.

Instructions for Electrostatic Discharge Protection

NOTICE

Risk of damaging electronic components

To avoid damage of electronic components, the operational site must be protected against electrostatic discharge (ESD).

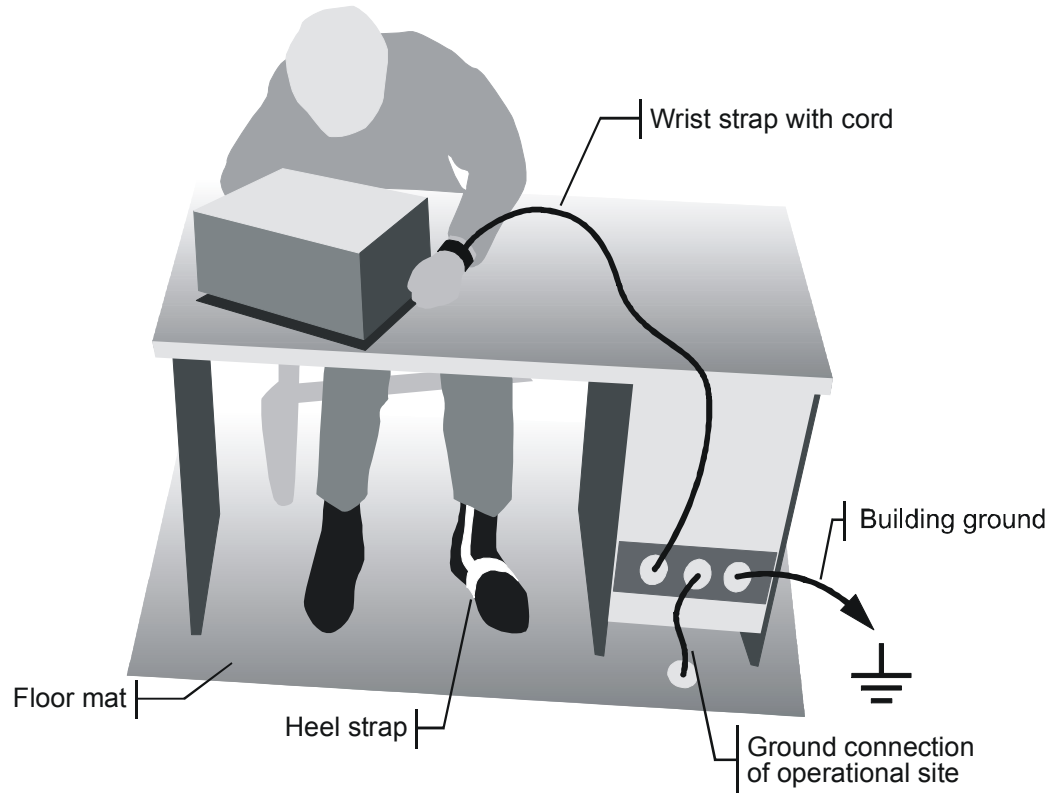

The following two methods of ESD protection may be used together or separately:

- Wrist strap with cord to ground connection
 - Conductive floor mat and heel strap combination
-

Instrucciones para la protección contra descargas electrostáticas

AVISO

Riesgo de avería de los componentes electrónicos

Para evitar averías en los componentes electrónicos, el área de trabajo tiene que estar protegido contra descargas electrostáticas ESD (electrostatic discharge).

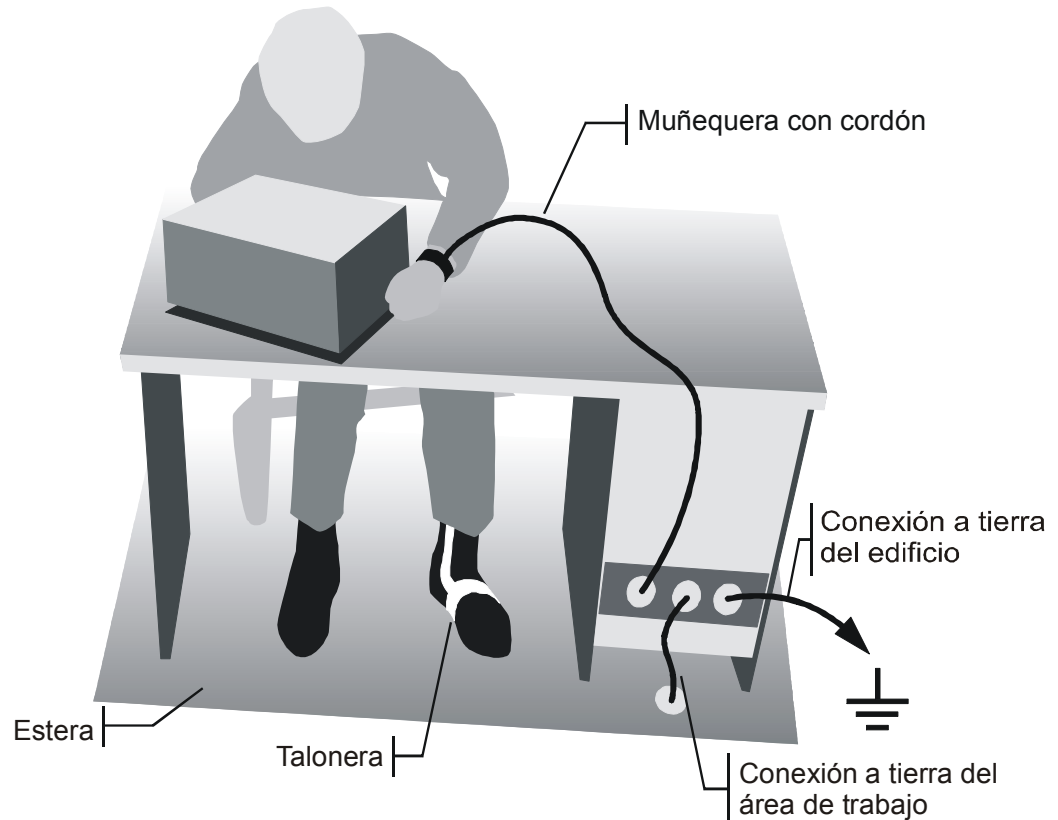

Los siguientes dos métodos de protección ESD pueden ser usados juntos o separados:

- Muñequera con cordón para conexión a tierra
- Combinación de estera antiestática y talonera

Safety Instructions for Units with Removable Cabinet

⚠ WARNING

Danger of injuries

When removing the rear feet, the unit can slip out of the cabinet.

Put the unit onto the front handles, before removing the rear feet and taking off the cabinet. Thus the risk of personal injuries and damages to the unit is avoided.

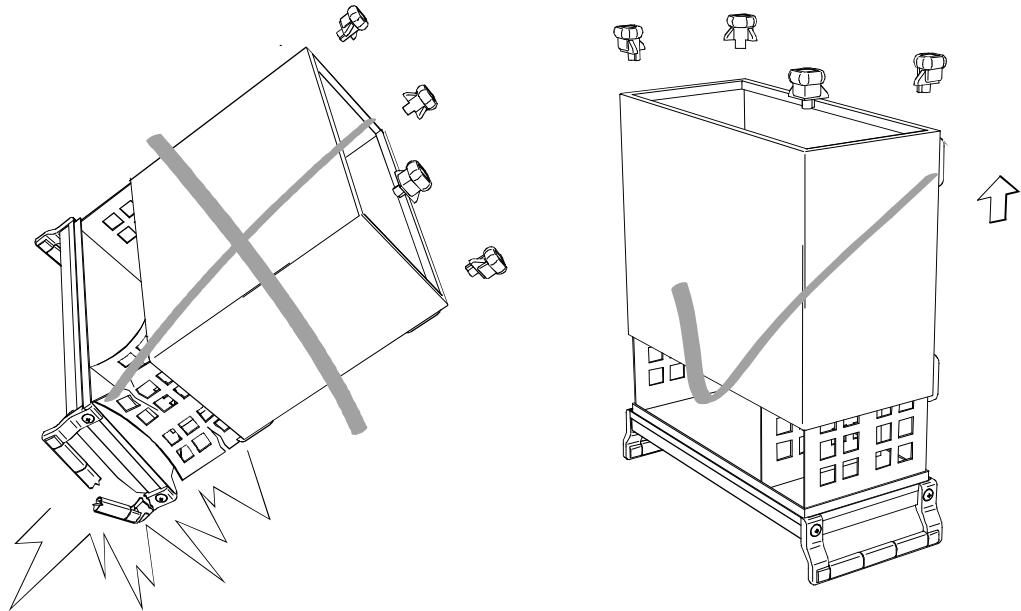

When mounting the cabinet take care not to pen in the fingers. Also pay attention not to damage or pull off cables. Screw the rear feet back on immediately after mounting the cabinet. Do not move the unit with the rear feet missing.

Informaciones de seguridad para aparatos con tubo de quita y pon

⚠ ADVERTENCIA

Peligro de heridas

Al sacar los piés de la pared posterior puede deslizarse el aparato fuera de la caja.

Posicionar el aparato de manera segura sobre las asas delanteras, antes de sacar los piés de la pared posterior y entonces sacar la caja. De esta manera evitarán el riesgo de daños en personas y daños en el aparato.

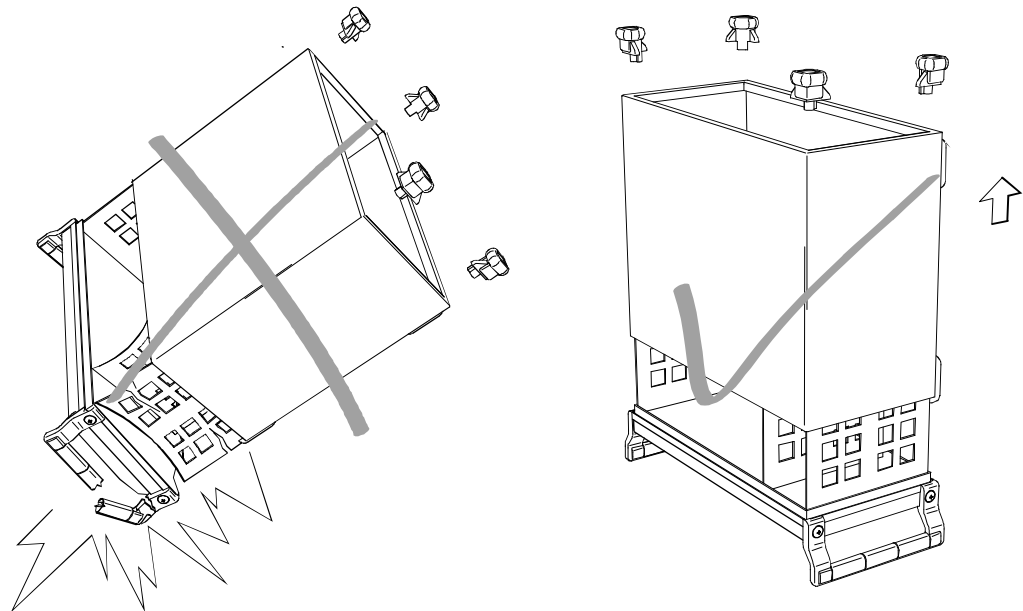

Existe el riesgo de heridas en el momento de poner otra vez la caja, como por ejemplo posiblemente engancharse los dedos. Por favor tengan además en cuenta de que no se enganchen o desconecten cables. Por favor atornillen los piés de la pared posterior directamente despues de poner la caja. No muevan el aparato nunca sin que los piés de la pared posterior estén atornillados.

Procedure in Case of Service and Ordering of Spare Parts

This section contains information on shipping an instrument to your service center and ordering spare parts.

Please contact your local Rohde & Schwarz service center if you need service or repair work of your equipment or to order spare parts. The list of the Rohde & Schwarz representatives is provided at the beginning of this service manual. You can find the current address of your representative on our homepage www.rohde-schwarz.com. Navigate to Service & Support / Service Locations.

Shipping the Instrument

We require the following information in order to answer your inquiry fast and correctly and to determine whether the warranty is still valid for your instrument:

- Instrument model
- Serial number
- Firmware version
- Must the instrument be returned with this firmware?
- Detailed error description in case of repair
- Indication of desired calibration
- Contact person for possible questions

In some countries, an RMA process is available for the return shipment of the instrument. For details, contact your local representative.

When shipping the instrument, be careful to provide for sufficient mechanical and antistatic protection.

- Use the original packaging for transporting or shipping the instrument. The protective caps for the front and rear prevent damage to the operating elements and the connectors.
- If you do not use the original packaging, provide for sufficient padding to prevent the instrument from slipping inside the box. Wrap antistatic packing foil around the instrument to protect it from electrostatic charging.

Rohde & Schwarz offers repair and calibrations of the test systems it produces. The calibration documentation fulfills ISO 17025 requirements.

Shipping Defective Modules

Also when shipping a module, be careful to provide for sufficient mechanical and antistatic protection.

- Ship the module in a sturdy, padded box.
- Wrap the module in antistatic foil.

If the packaging is only antistatic but not conductive, additional conductive packaging is required. The additional packaging is not required if the tightly fitting packaging is conductive.

Exception:

If the module contains a battery, the tightly fitting packaging must always consist of antistatic, non-chargeable material to protect the battery from being discharged.

Ordering Spare Parts

To deliver spare parts promptly and correctly, we need the following information:

- Stock number (see list of spare parts in chapter "Documents")
- Designation
- Component number according to list of spare parts
- Number of pieces
- Instrument type for which the spare part is needed
- Instrument stock number
- Instrument serial number
- Contact person for possible questions

Refurbished Modules

Refurbished modules are an economical alternative to original modules. Bear in mind that refurbished modules are not new, but repaired and fully tested parts. They may have traces from use, but they are electrically and mechanically equivalent to new modules.

Your Rohde & Schwarz representative will be happy to inform you about which modules are available as refurbished modules.

Taking Back Defective Replaced Modules

Defective modules of the replacement program which cannot be repaired are taken back within three months following delivery. A repurchasing value is credited.

Excluded are parts which cannot be repaired, e.g. printed boards that are burnt, broken or damaged by attempts to repair them, incomplete modules, and parts with severe mechanical damage.

Please return the defective replacement modules, together with the accompanying document for returned merchandise, which you received with the spare module. We need the following information:

- Stock number, serial number and designation of the removed part
- Detailed error description
- Stock number, serial number and type of instrument from which the module was removed
- Date of removal
- Name of the engineer/technician who replaced the module
- R&S ordering number
- Service reference number (if available)

Contents - Chapter 1 "Performance Test"

1 Checking the Rated Characteristics	1.1
Measuring Equipment and Accessories	1.1
Test Assemblies	1.3
Standard Test Assembly for Analog Modulations	1.3
Test Assembly for Pulse Modulation	1.3
Test Assembly for Residual AM	1.4
Test Assembly for SSB Phase Noise and Jitter	1.4
Test Assembly for Output Impedance (VSWR)	1.5
Test Assembly for Setting Time	1.5
Preparation, Recommended Test Frequencies and Levels	1.6
Test Procedures	1.7
Reference Frequency	1.7
Output of Internal Reference	1.7
Input for External Reference	1.8
Frequency	1.9
Frequency Setting	1.9
Setting Time (only for Option R&S SMC-K4)	1.9
Spectral Purity	1.11
Harmonics	1.11
Nonharmonics	1.12
Non-systematic nonharmonics	1.13
Wideband Noise	1.14
SSB Phase Noise	1.16
Residual FM	1.17
Residual AM	1.19
Level Data	1.21
Level Uncertainty	1.21
Output Impedance	1.23
Setting Time (only for Option R&S SMC-K4)	1.24
Internal Modulation Generator	1.25
Amplitude Modulation	1.27
AM Setting Uncertainty	1.27
AM Distortion	1.29
AM Frequency Response	1.30
Synchronous PhiM with AM	1.31
Frequency Modulation	1.32
Test Methods	1.32
FM Setting Uncertainty	1.32
FM Distortion	1.33
FM Frequency Response	1.34
Synchronous AM with FM	1.34
Carrier Frequency Offset with FM	1.36
Phase Modulation	1.37
PhiM Setting Uncertainty	1.37
PhiM Distortion	1.38
PhiM Frequency Response	1.39

Pulse Modulation1.40
 ON/OFF Ratio1.40
 Rise/ Fall Time1.41
 Video Crosstalk1.42
Pulse Generator1.43
 PULSE VIDEO1.43

1 Checking the Rated Characteristics

This performance test describes the steps for testing the R&S SMC Signal Generator family and the installed options with respect to function and compliance with specifications.

In the following, the term DUT (Device under Test) is used for any signal generator of this family. The tests to be performed depend on the installed options. The values are given in the data sheet of the respective instrument.

Measuring Equipment and Accessories

Table 1-1 Measuring equipment and accessories

Item	Type of Instrument	Required Characteristics	Suitable Instrument	R&S Order No.
1	Frequency counter	1 Hz to RF_{max} , resolution 0.1 Hz (included in spectrum analyzer item 18)		
2	Reference source for SSB noise measurements	Identical generator as DUT or generator with at least 10 dB lower SSB noise as DUT Frequency range up to RF_{max}	R&S SMC100A with suited frequency option R&S SMB100A with suited frequency option Reference Synthesizer or R&S SMA100A with option R&S SMA-B106 or R&S SMU200A with option R&S SMU-B106	1411.4002.02 1406.6000.02 1158.2878 1400.0000.02 1405.0809.02 1142.2005.02 1141.8803.02
5	Signal generator	0.1 MHz to RF_{max}	R&S SMB with option R&S SMB-B106 R&S SMU with options R&S SMU-B106, -B10, -B31 or R&S SMA100A with option R&S SMA-B106	1406.6000.02 1407.2909.02 1141.2005.02 1400.0000.02 1405.0809.02
6	Phase noise test assembly	Phase Noise Test Set or Mixer: 10 MHz to RF_{max} , branching filter 20 MHz, DC decoupling after the mixer	R&S FSUP 8 or FSU or FSQ with phase noise measurement option Mixer: f < 1 GHz: Minicircuits ZFM2H 1 GHz < f < 6 GHz: Miteq DB0118LA2	1166.3506.08
7	Oscilloscope	Bandwidth \geq 100 MHz, two channels with DC coupling	Tektronix TDS 1012B or similar	
8	RF power meter	9 kHz to RF_{max}	R&S NRP with R&S NRP-Z91 R&S NRP-Z51 or R&S NRVS with R&S NRV-Z5 R&S NRV-Z51	1143.8500.02 1168.8004.02 1138.0005.02 1020.1809.02 0828.3818.02 0857.9004.02
9	Low-noise preamplifier	9 kHz to 1 MHz gain > 20 dB, input noise < 4 nV (1 Hz)	based an ADI AD829	

Item	Type of Instrument	Required Characteristics	Suitable Instrument	R&S Order No.
10	VSWR bridge	100 MHz to RF _{max} directivity > 30 dB	R&S ZRC or Agilent 773D	1039.9492.55
12	RF power amplifier	10 MHz to RF _{max} , power > 33 dBm	Mini Circuits ZHL-03-5WF	
13	Pulse generator	Pulse repetition frequency at least 10 kHz	R&S SMC100A or R&S SMB100A equipped with option K23 or R&S SMA100A	
14	AC/DC voltmeter	10 Hz to 100 kHz	R&S URE3	350.5315.03
15	Broadband FM demodulator	included in spectrum analyzer item 18		
16	RF attenuator	DC to RF _{max} , 10 dB, system N	R&S DNF	0272.4210.50
17	RF attenuator	DC to RF _{max} , 3 dB, system N	R&S DNF	0272.4010.50
18	RF analyzer & Demodulator for analog modulations & FM-demodulator	9 kHz to RF _{max} * 3	R&S FSMR26 with options R&S FSU-B25 R&S FS-B223 or R&S FSQ26 with options R&S FSU-B25 R&S FSQ K7	1166.3311.26 1044.9298.02 1157.1955.26 1155.5001.26 1044.9298.02 1141.1796.02
19	Feed-through termination	50 Ω, BNC system	R&S RAD	0289.8966.00

Test Assemblies

Standard Test Assembly for Analog Modulations

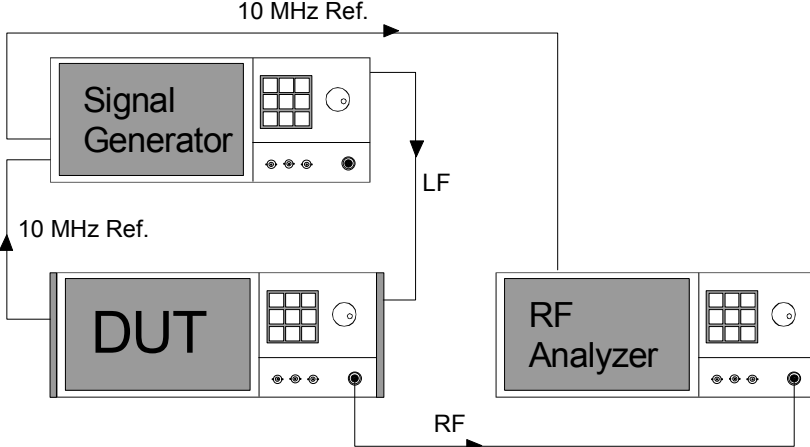
Test equipment	<ul style="list-style-type: none"> - RF analyzer (Table 1-1, item 18) - Signal generator (Table 1-1, item 5)
Test setup	<p>The RF analyzer is used as a modulation analyzer. The signal generator is used as modulation source in case of external modulation.</p>
	 <p>The diagram shows three main components: a Signal Generator, a DUT (Device Under Test), and an RF Analyzer. The Signal Generator outputs a 10 MHz reference signal to the DUT and an LF signal to the RF Analyzer. The DUT also outputs a 10 MHz reference signal to the RF Analyzer. The DUT outputs an RF signal to the RF Analyzer.</p>

Test Assembly for Pulse Modulation

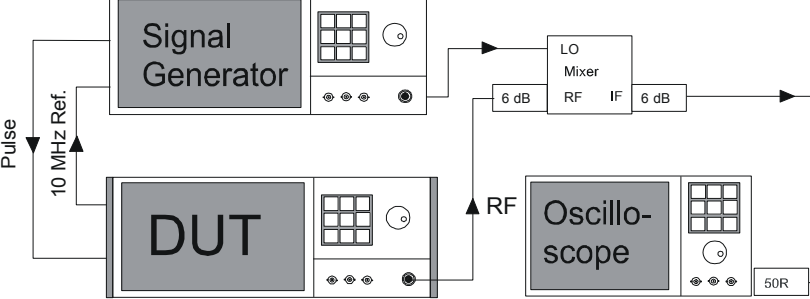
Test equipment	<ul style="list-style-type: none"> - Oscilloscope (Table 1-1, item 3) - Signal generator (Table 1-1, item 5) - Mixer
Test setup	<p>The pulsed RF is mixed down to DC in phase and analyzed with an oscilloscope.</p>
	 <p>The diagram shows three main components: a Signal Generator, a DUT (Device Under Test), and an Oscilloscope. The Signal Generator outputs a 10 MHz reference signal to the DUT and a Pulse signal to the LO Mixer. The DUT outputs an RF signal to the LO Mixer. The LO Mixer outputs an IF signal to the Oscilloscope. The Oscilloscope is terminated with a 50R resistor.</p>

Test Assembly for Residual AM

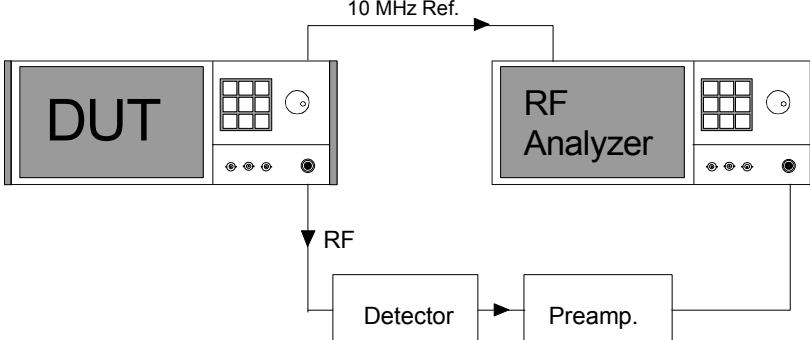
Test equipment	<ul style="list-style-type: none"> - RF analyzer (Table 1-1, item 18) - Zero Bias Schottky Detector (Table 1-1, item 20) - Low Noise Preamplifier 10 Hz – 30kHz, >30dB Gain (Table 1-1, item 9)
Test setup	

Test Assembly for SSB Phase Noise and Jitter

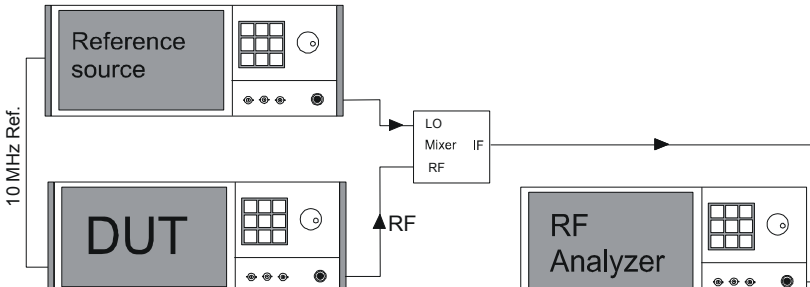
Test equipment	<ul style="list-style-type: none"> - SSB reference source (Table 1-1 item 2), - Phase noise test assembly consisting of - Spectrum analyzer (Table 1-1 item 18)
Test setup	

Test Assembly for Output Impedance (VSWR)

<p>Test equipment</p>	<ul style="list-style-type: none"> - VSWR bridge (Table 1-1, item 10), - Second signal generator (Table 1-1, item 5) - Spectrum analyzer (Table 1-1, item 18)
<p>Test setup</p>	
	<p>Note: The INPUT of the directional coupler is directly screwed to the DUT. The second signal generator is connected to the line connector (OUTPUT), the analyzer to the coupling output (COUPLED) of the directional coupler.</p>

Test Assembly for Setting Time

<p>Test equipment</p>	<ul style="list-style-type: none"> - Spectrum analyzer (Table 1-1, item 18) - Pulse generator (Table 1-1, item 13)
<p>Test setup</p>	

Preparation, Recommended Test Frequencies and Levels

To ensure proper conditions for the performance test and prevent setting errors, the instrument must be prepared as follows:

- Allow for a minimum **warm-up time of 30 minutes** at ambient temperature.
- Carry out all **internal adjustments** (see operating manual, chapter 4, section "Internal Adjustment - Setup-System").
- Press **PRESET** to establish a defined **initial** state before configuring a new measurement.

The following sections describe the **procedures** for checking the rated values. The **values** are specified in the **data sheet**. Additional uncertainties introduced by the measurement equipment must be taken into account when checking the rated values.

The following table lists the important internal switch point frequencies and the recommended measurement frequencies derived from these frequencies. We recommend measurements at these frequencies unless particular test frequencies are specified. In the following, RF_{max} is the maximal settable RF (depending on installed options).

Table 1-1 Range limits, main test frequencies for CW Mode

Range	Frequency	Hardware switching points	Recommended test frequencies
Direct DDS Synthesis	$9 \text{ kHz} \leq f \leq 23.4375 \text{ MHz}$	23.4375 MHz	9 kHz; 200 kHz; 1 MHz; 5 MHz; 10 MHz; 23.4375 MHz
Divider /128	$23.4375 \text{ MHz} < f \leq 25 \text{ MHz}$	25 MHz	23.438 MHz; 24.999 MHz
Divider /64	$25 \text{ MHz} < f \leq 50 \text{ MHz}$	32 MHz; 50 MHz	25.01 MHz; 31.99 MHz; 49.99 MHz
Divider /32	$50 \text{ MHz} < f \leq 100 \text{ MHz}$	71 MHz; 100 MHz	50.01 MHz; 70.9 MHz; 99.9 MHz
Divider /16	$100 \text{ MHz} < f \leq 200 \text{ MHz}$	141 MHz; 200 MHz	100.1 MHz; 140.9 MHz; 199.9 MHz
Divider /8	$200 \text{ MHz} < f \leq 400 \text{ MHz}$	283 MHz; 400 MHz	200.1 MHz; 282.9 MHz; 399.9 MHz
Divider /4	$400 \text{ MHz} < f \leq 800 \text{ MHz}$	566 MHz; 800 MHz	400.1 MHz; 565.9 MHz; 799.9 MHz
Divider /2	$800 \text{ MHz} < f \leq 1.6 \text{ GHz}$	1131 MHz; 1600 MHz	800.1 MHz; 1100 MHz; 1130.9 MHz; 1599.9 MHz
Base octave	$1.6 \text{ GHz} < f \leq 3.2 \text{ GHz}$	2263 MHz	1600.1 MHz; 2262.9 MHz; 3.2 GHz

RF_{max} is the maximum output frequency of the instrument according to its frequency option (1.1 GHz or 3.2 GHz).

For **high-resolution measurements** in the entire frequency range, a logarithmic frequency grid in 1-2-5 sequence is recommended up to 50 MHz; above this value, linear 50 MHz steps should be used up to the upper limit frequency.

The recommended **test levels** are at the upper and lower switching threshold of the attenuator. The electronic attenuator of the DUT is switched depending on frequency, modulation parameters and level according to an internal stored table in approximately 4 dB steps. The switching thresholds can be detected under **Attenuator fixed range** in the **Level** menu. After setting all other parameters, the threshold level can be detected by level variation. The level at which the attenuator fixed range changes is the threshold. By measuring at the last level setting of one range and the first level setting of the next range, the internal setting range borders are used. In the following, P_{min} is the lowest level before switching the attenuator, and P_{max} the highest.

Test Procedures

Reference Frequency

Output of Internal Reference

Important: Allow the DUT to warm up for at least 2 hours before the measurement.

Test equipment	RF power meter (Table 1-1 , item 8), Frequency counter (Table 1-1 , item 1)
Test setup	➤ Connect an RF power meter to the REF OUT output (on rear panel).
Measurement	➤ Measure the output level. It should be within ± 3 dB of the data sheet specifications.
Test setup	➤ Connect a calibrated frequency counter to the REF OUT output (on rear panel).
Measurement	➤ Measure the frequency. ⇒ The frequency deviation must not exceed the sum of deviations resulting from the frequency error in the rated temperature range and from aging.

Input for External Reference

Test equipment	<ul style="list-style-type: none"> - Frequency counter (Table 1-1, item 1) - Signal generator (Table 1-1, item 5) 						
Test method	<p>The external reference input frequency of the DUT is varied according to the data sheet and the RF output signal frequency is controlled with a frequency counter to follow this variation.</p>						
Preparation of measurement	<ul style="list-style-type: none"> ➤ Connect the signal generator RF output to the REF IN input for the external reference (on rear panel) of the DUT. Connect a calibrated frequency counter to the RF output. Synchronize the signal generator and the frequency counter. ➤ Setting on DUT: <ul style="list-style-type: none"> - RF on - Level: 0 dBm (suitable level for the frequency counter) - Frequency: 1 GHz - Setup ⇨ Reference Oscillator ⇨ Source: External ➤ Setting on signal generator: <ul style="list-style-type: none"> - RF on - Level: 0 dBm 						
Measurement	<ul style="list-style-type: none"> ➤ Set the signal generator frequency to 9.99997 MHz and 10.0003 MHz. Measure the output frequency of the DUT. <table border="1" data-bbox="657 963 1385 1059" style="margin-left: 40px;"> <tr> <td style="padding: 2px;">Signal generator frequency</td> <td style="padding: 2px;">9.99997 MHz</td> <td style="padding: 2px;">10.0003 MHz</td> </tr> <tr> <td style="padding: 2px;">DUT frequency</td> <td style="padding: 2px;">999.997 MHz</td> <td style="padding: 2px;">1000.03 MHz</td> </tr> </table> <p style="margin-left: 40px;">There must be no relative frequency error and no error message in the display of the DUT.</p>	Signal generator frequency	9.99997 MHz	10.0003 MHz	DUT frequency	999.997 MHz	1000.03 MHz
Signal generator frequency	9.99997 MHz	10.0003 MHz					
DUT frequency	999.997 MHz	1000.03 MHz					

Frequency

Frequency Setting

Test method	The frequency setting is checked by running the internal synthesizer adjustments to check the frequency overlap of the VCOs
Measurement	➤ Run: Setup ⇒ Internal Adjustments ⇒ Adjust Synthesis There must be no error message.

Setting Time (only for Option R&S SMC-K4)

Test assembly	See section " Test Assembly for Setting Time ", page 1.5. For measuring after IEC/IEEE bus delimiter the EOI-line of the IEC/IEEE bus is used as trigger signal instead of the pulse generator.
Test method	The spectrum analyzer operates as an FM demodulator. A controller transmits the start and the stop frequency via the IEC/IEEE bus. The analyzer is triggered by the positive edge on the EOI line of the IEC/IEEE bus or the trigger pulse in list mode. At switch over from start to stop frequency, the settling procedure is displayed on the screen of the analyzer.
Preparation of measurement	<ul style="list-style-type: none"> ➤ Synchronize the reference frequencies of the DUT and the analyzer. ➤ Make IEC/IEEE bus and RF connections. ➤ Connect spectrum analyzers trigger connector to EOI line (pin 5) of IEC/IEEE bus. ➤ Settings on DUT: <ul style="list-style-type: none"> - Frequency: start frequency unmodulated, - Level: 0 dBm ➤ Settings on spectrum analyzer: <ul style="list-style-type: none"> - AMPT/REF LEVEL 0 dBm - FREQ/CENTER/STOP FREQUENCY - FM DEMOD ON - DEMOD BW 50 kHz - RANGE /DEVIATION PER DIV 200 Hz - MEAS TIME 10 ms - TRIGGER EXTERN - External triggering by positive edge at 1.4 V.

Measurement	<ul style="list-style-type: none"> ➤ Settings on analyzer: - Set the analyzer to the stop frequency ➤ Set the DUT to the start frequency f_{start} ➤ Send the stop frequency f_{stop} from the controller to the DUT. <ul style="list-style-type: none"> ⇨ The externally triggered analyzer displays the settling curve. The setting time is defined as the time from which on the frequency deviation from the stop frequency is less than the specified deviation in the data sheet. ➤ Repeat the measurement with ALC state Off: <ul style="list-style-type: none"> ⇨ RF⇨Automatic Level Control⇨State⇨OFF (Sample & Hold)
-------------	--

Recommended test frequencies	<table border="1"> <thead> <tr> <th>f_{start}</th> <th>f_{stop}</th> <th>Deviation</th> </tr> </thead> <tbody> <tr> <td>23.4 MHz</td> <td>1100 MHz</td> <td>±110 Hz</td> </tr> <tr> <td>799.9 MHz</td> <td>800.1 MHz</td> <td>±80 Hz</td> </tr> <tr> <td>800.1 MHz</td> <td>799.9 MHz</td> <td>±80 Hz</td> </tr> </tbody> </table>	f_{start}	f_{stop}	Deviation	23.4 MHz	1100 MHz	±110 Hz	799.9 MHz	800.1 MHz	±80 Hz	800.1 MHz	799.9 MHz	±80 Hz
f_{start}	f_{stop}	Deviation											
23.4 MHz	1100 MHz	±110 Hz											
799.9 MHz	800.1 MHz	±80 Hz											
800.1 MHz	799.9 MHz	±80 Hz											

Example of Measurement:

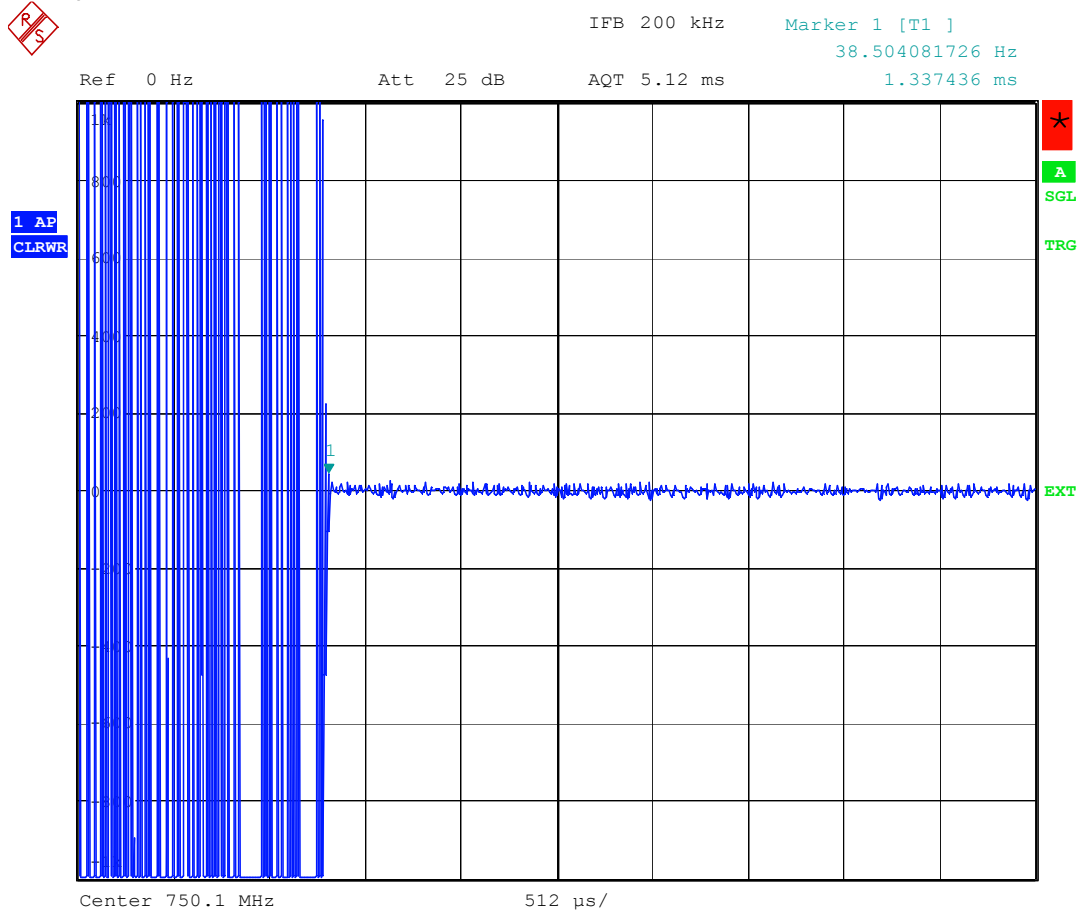

Date: 14.FEB.2008 18:58:23

The marker is set to the time when the trace enters the specified interval of 750.1 MHz ± 75 Hz. The setting time is 1.34 ms.

Spectral Purity

Harmonics

Test equipment	Spectrum analyzer (Table 1-1 , item 18)
Test setup	<ul style="list-style-type: none"> ➤ Connect the spectrum analyzer to the RF output of the DUT. ➤ Synchronize the reference frequencies of analyzer and DUT.
Measurement	<ul style="list-style-type: none"> ➤ Settings on analyzer: Reference level = 20 dBm, 10 dB/div. Span 0 Hz, Resolution bandwidth 10 kHz ➤ Settings on DUT: - Frequency: test frequencies, unmodulated - Level: test levels ➤ First measure the level of the fundamental P_f at the test frequency f as a reference. Then measure the signal levels P_{2*f} and P_{3*f} at twice and three times the carrier frequency f. ⇒ The harmonic spacing is the measured harmonic level referred to the fundamental: HD2 = $P_f - P_{2*f}$ HD3 = $P_f - P_{3*f}$ (in dBc = referred to the carrier)
Recommended test frequencies and levels	<p>Test frequencies: 1 MHz, 32.1 MHz, 71.1 MHz, 141.1 MHz, 283.1 MHz, 567 MHz, 1132 MHz, 2264 MHz</p> <p>Test level: +8 dBm</p>

Nonharmonics

Test equipment	Same as for harmonics
Test setup	Same as for harmonics
Measurement	<ul style="list-style-type: none"> ➤ Setting on analyzer: Reference level = 0 dBm, 10 dB/div. Span 50 Hz, Resolution bandwidth 10 Hz ➤ Setting on DUT Level = 0 dBm ➤ First the carrier level P_f is measured at the test frequency f as reference and then the signal level P_{search} is measured at the analyzer search frequency. ⇒ The nonharmonic spacing D is the measured level referred to the reference level: $D = P_f - P_{search}$ (in dBc = referred to the carrier)
	<p>Note: <i>Some of the nonharmonics suppression values measured might be outside the analyzer specifications. In case of doubt, repeat the measurement with a 3 dB attenuator at the analyzer input. If the nonharmonic spacing changes the nonharmonic is due to the analyzer.</i></p> <p>Alternative: <i>Check with a second source with differing synthesizer architecture (not a R&S SMC)</i></p>

Recommended settings and search frequencies:

DUT Frequency	Analyzer search frequency
13 MHz	9 MHz
13 MHz	22 MHz
17 MHz	15 MHz
23.4375 MHz	6.25 MHz
23.4375 MHz	29.6875 MHz
1087.732 MHz	1087.796 MHz
3075.656 MHz	3075.72 MHz

Non-systematic nonharmonics

Measurement	<ul style="list-style-type: none">➤ Settings on DUT:<ul style="list-style-type: none">- Test frequency 1 GHzTest level 0 dBm unmodulated➤ Recommended settings on analyzer:<ul style="list-style-type: none">- Max peak detector- Filter Type: FFT- Ref-Level 0 dBm➤ - Set analyzer center frequency to 1 GHz, span to 40 MHz and resolution bandwidth to 2 kHz- Measure carrier level P- all signals other than the carrier must be below P – 60 dB- Set analyzer span to 100 kHz and resolution bandwidth to 200 Hz- all signals other than the carrier must be below P – 60 dB
	<p>Note: <i>Some of the nonharmonics suppression values to be measured might be outside analyzer specifications. In case of doubt, repeat the measurement with a 3 dB attenuator pad at the analyzer input. If the nonharmonics suppression changes the nonharmonics are due to the analyzer. Because of the bell-shaped noise of the analyzer near the carrier, smaller resolution bandwidths may have to be used. To exclude amplitude independent nonharmonics of the analyzer, use a second generator with different synthesis architecture.</i></p>

Wideband Noise

Test assembly	Connect spectrum analyzer to RF socket of the DUT.
Test method	The carrier power is measured first. Then the center frequency of the analyzer is increased by 10 MHz and the noise power in a small bandwidth is measured. The difference of the carrier power and the noise power in 1 Hz bandwidth, which is calculated from the measurement, is defined as wideband noise. Because wideband noise degrades with lower electronic levels in front of the output step attenuator the output level of the generator has to be set to the lowest level before switching the step attenuator.
Measurement	<ul style="list-style-type: none"> ➤ Settings on DUT: <ul style="list-style-type: none"> - frequency: test frequency - Level: 0 dBm - determine Att-fixed range upper Level P_{upper}: - \Rightarrow RF \Rightarrow Level \Rightarrow Att fixed range \Rightarrow upper - set level to $P_{upper} + 0.1$ dB ➤ Settings on analyzer: <ul style="list-style-type: none"> - center: test frequency - reference level $P_{upper} + 1$ dB - Attenuator $D_{min} = P_{upper} - P_{1dBm} + 5dB \Rightarrow$ round to next larger available Attenuation of the analyzer (P_{1dBm} = analyzer P1dB level at test frequency) - span 110 kHz - Detector RMS - Sweep Time Manual 1s - switch on channel power measurement with 100 kHz bandwidth ➤ Determine the channel power with the center frequency of the analyzer set to the test frequency and note it down as P_{ref}. ➤ Increase the analyzer center frequency by 9.9 MHz. ➤ Inhibit the switching of the attenuator with AMPT RF ATTEN MANUAL without entering a value so that the input mixer is not overdriven. ➤ Lower the reference level of the analyzer by 20 dB, read the new channel power P_{noise}. ➤ Minimize the output level on the DUT by means of RF OFF, read the channel power P_{res}.

<p>Evaluation</p>	<p>➤ If the power $P_{res} < P_{noise} - 0.41 \text{ dB}$ the inherent noise power of the analyzer can be subtracted: $W_{Noise} = -P_{ref} + 10 * \log_{10}(10^{P_{noise}/10} - 10^{P_{res}/10}) - 50 \text{ dB}$</p> <p>➤ If the power $P_{res} > P_{noise} - 0.41 \text{ dB}$ the analyzer resolution is not sufficient for a precise measurement. The true result is in such case certainly more than 10 dB below the measured value. The result than is at least: $W_{Noise} = -P_{ref} + P_{noise} - 50 \text{ dB} - 10 \text{ dB}$</p> <p>⇒ The difference between the (possibly corrected) power P_{noise} in dBm and the power P_{ref} in dBm is the broadband noise floor in dBc.</p>
<p>Recommended test frequencies</p>	<p>1.02 MHz, 23.438 MHz; 51 MHz, 101 MHz, 201 MHz, 401 MHz, 801 MHz, 1100 MHz, 1601 MHz, 2200 MHz and 3200 MHz</p>

SSB Phase Noise

The SSB phase noise of the DUT can be measured direct if a Phase Noise Test Set is available. An R&S FSUP or any other analyzer with phase noise option is suitable if its own phase noise is at least 6 dB less than the guaranteed DUT Phase noise in the data sheet.

Measurement: Set the Level of the DUT to 0 dBm and measure the phase noise at 20 kHz offset with the analyzer in phase noise mode.

If no suited analyzer is available, the Phase noise can be measured with the aid of a second generator and a mixer:

Test assembly	See section " Test Assembly for SSB Phase Noise and Jitter ", page 1.4.
Test method	The two generators are set to the test frequency and synchronized with a phase offset of 90° (phase quadrature). Mixing to 0 Hz suppresses the RF carrier. Due to the phase quadrature, the mixer supplies a voltage representing the phase difference between the input signals. This voltage is measured with the spectrum analyzer.
Measurement	<ul style="list-style-type: none"> ➤ Set the levels of the two generators in accordance with the specifications of the mixer used. (For the MITEQ-DB0118 mixer set the LO-level to +10 dBm and the RF-level to 0 dBm.) ➤ Settings of the DUT: <ul style="list-style-type: none"> - PM int - PM deviation 0.01 rad - Modulation frequency 19 kHz ➤ Settings on the analyzer: <ul style="list-style-type: none"> - Center frequency 19.5 kHz - Span 2 kHz - Input coupling DC - Attenuator manual 0 dB - average on, count = 10 - average mode: linear/ power - Filter Type: FFT - Resolution Bandwidth 10 Hz - set marker to 19 kHz. - set delta marker to 20 kHz ➤ Adjust the phase of the DUT for phase quadrature: Set the Delta Phase in the Frequency/Phase menu for maximum marker readout at 19 kHz in the Delta Phase range of 0° to 180°. Note down the relative Delta marker level D. ➤ Calculate the SSB phase noise in dbc/Hz: <ul style="list-style-type: none"> - The Delta Marker measures the noise in 10 Hz bandwidth. The power in 1 Hz bandwidth is one tenth of this power: $\log_{10}(10)$ - The PM with a modulation rate of 0.01 rad is equivalent to a phase noise of -46 dBc. - In baseband the two sidebands fall on each other: -6dB - The phase noises of the two generators add together: - 3dB if they are of the same type. <p>If the reference generator is of the same type as the DUT: $PN = D - 10 * \log_{10}(10) - 46 \text{ dB} - 3 \text{ dB}$ $PN = D - 59 \text{ dB}$</p> <p>If the phase noise of the reference generator is at least 10 dB better than the phase noise of the DUT: $PN = D - \log_{10}(10) - 46 \text{ dB}$ $PN = D - 56 \text{ dB}$</p>
Recommended test frequencies	1 GHz, RFmax

Residual FM

Test assembly	Connect spectrum analyzer to RF socket of the DUT.
Test method	The FM demodulator of the analyzer is used to FM-demodulate the CW signal of the DUT. By setting the AF-low-pass and high-pass-filters the RMS value in the desired bandwidth can be measured. The value displayed is the sum of the analyzer residual FM and the DUT residual FM. Because they are uncorrelated, the displayed result is worse than residual RMS of the DUT alone. Therefore, if the sum is in tolerance according to the data sheet the DUT is also in tolerance.
Measurement	<ul style="list-style-type: none"> ➤ Settings on DUT: <ul style="list-style-type: none"> - frequency: 1 GHz - Level: 0 dBm ➤ Settings on analyzer: <ul style="list-style-type: none"> - CENTER: 1 GHz - REFERENCE LEVEL: 1 dBm - FM DEMOD - FM DEMOD ⇨ MEAS TIME: 100ms - FM DEMOD ⇨ DEMOD BW: 200 kHz - FM DEMOD ⇨ AF-FILTER ⇨ HIGH PASS AF FILTER: 300 Hz - FM DEMOD ⇨ AF-FILTER ⇨ LOW PASS AF FILTER: 3 kHz ➤ The Residual FM in the frequency range 300 Hz – 3 kHz is the RMS value displayed. ➤ Repeat the measurement with setting the HIGH PASS AF FILTER: to 20 Hz and the LOW PASS AF FILTER to 23 kHz. ➤ Limits (and filters) according datasheet

Example:



IFB 2 MHz

Ref 0 Hz

Att 30 dB

AQT 50 ms

1 AP
CLRWR

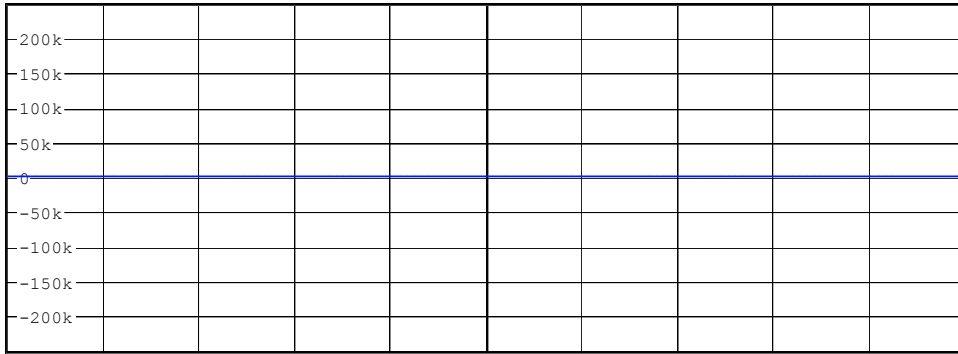

Center 1 GHz

5 ms/

Frequency Modulation Summary

Coupling	DC	Carrier Offset	45.639 Hz
Deviation	+peak 12.93 Hz	Carrier Power	-0.91 dBm
	-peak -12.41 Hz	Modulation Frequency	--- Hz
	±peak/2 12.67 Hz	Sampling Rate	250 kHz
	RMS 3.465 Hz	Record Length	12501
		Demod Bandwidth	200 kHz
		AF Filter	HP 20 Hz
			LP 23 kHz

Date: 22.FEB.2008 17:35:25

Residual FM = 3.465 Hz

Residual AM

Test assembly	Connect spectrum analyzer to RF socket of the DUT.
Test method	The FM demodulator of the analyzer is used to AM-demodulate the CW signal of the DUT. By setting the AF-low-pass and high-pass-filters the RMS value in the desired bandwidth can be measured. The value displayed is the sum of the analyzer residual AM and the DUT residual AM. Because they are uncorrelated, the displayed result is worse than residual RMS of the DUT alone. Therefore, if the sum is in tolerance according to the data sheet the DUT is also in tolerance.
Measurement	<ul style="list-style-type: none"> ➤ Settings on DUT: <ul style="list-style-type: none"> - frequency: 1 GHz - Level: 0 dBm ➤ Settings on analyzer: <ul style="list-style-type: none"> - CENTER: 1 GHz - REFERENCE LEVEL: 1 dBm - AMPT ⇒ RF ATTEN MANUAL: 10 dB - FM DEMOD - FM DEMOD ⇒ RESULT DISPLAY ⇒ AM - FM DEMOD ⇒ MEAS TIME: 100ms - FM DEMOD ⇒ DEMOD BW: 200 kHz - FM DEMOD ⇒ AF-FILTER ⇒ HIGH PASS AF FILTER: 20 Hz - FM DEMOD ⇒ AF-FILTER ⇒ LOW PASS AF FILTER: 20 kHz ➤ The Residual AM in the frequency range 20 Hz – 23 kHz is the RMS value displayed.

Example:



IFB 2 MHz

Ref 0 % * Att 5 dB AQT 200 ms

1 AP
CLRWR

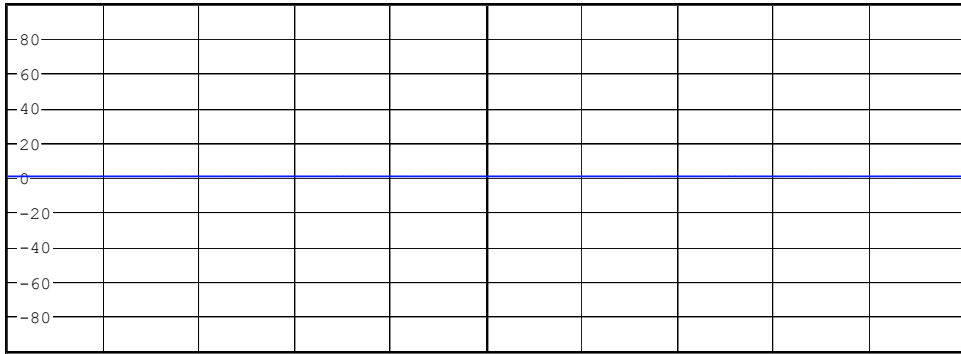

Center 1 GHz 20 ms/

Amplitude Modulation Summary

Modulation Depth	0.022 %	Carrier Power	-0.87 dBm
Modulation +peak	0.022 %	Modulation Frequency	--- Hz
-peak	-0.023 %	Sampling Rate	250 kHz
±peak/2	0.022 %	Record Length	50001
RMS	0.005 %	Demod Bandwidth	200 kHz
		AF Filter	HP 20 Hz
			LP 23 kHz

Date: 25.FEB.2008 16:33:44

Residual AM = 0.005 %

Level Data

Level Uncertainty

Test method	The level uncertainty is measured in two steps. First, the frequency response is measured at a fixed level with high frequency resolution. Then the level dependant uncertainty is measured at fixed frequencies over the specified range.
Test equipment	<ul style="list-style-type: none"> - Power meter (Table 1-1, item 8) - Spectrum analyzer (Table 1-1, item 18) - Low-noise preamplifier (Table 1-1, item 9)

Test method for levels in measurement range of power meter

Test setup	Connect power meter to RF output socket.
Measurement	<ul style="list-style-type: none"> ➤ Setting on DUT: <ul style="list-style-type: none"> - Levels : +13 dBm in level Mode AUTO ➤ Measure the level P_{absolute} at the recommended test frequencies up to RF_{max}. <ul style="list-style-type: none"> ⇒ The level error is the deviation of the measured level from the set value. ➤ Repeat this measurement at + 13 dBm in level Mode OFF (Sample & Hold) at 200 kHz, 25 MHz, 100 MHz, 1.1 GHz, 2.2 GHz and 3.2 GHz
Recommended test frequencies for the level frequency response measurement	200 kHz, 500 kHz, 1 MHz; 5 MHz; 10 MHz; 23.4375 MHz 25 MHz to 95 MHz in 10 MHz Steps 112.5 MHz to 3.2 GHz in 25 MHz Steps

Test method for low levels

<p>Test principle</p>	<p>Low levels can only be measured using a frequency selective measurement instrument. Spectrum analyzers with digital IF are best suited for this measurement due to their low linearity error. The absolute accuracy of these analyzers is not sufficient for this measurement. So a relative measurement referred to the measurements performed with the power meter is used to increase the accuracy of the measurement.</p> <p>Only by switching the input attenuator and preamplifier (when available) of the analyzer the needed dynamic range of more than 120 dB can be reached. After switching the analyzer attenuator or preamplifier, a continuity calibration is to be carried out. It is therefore recommended to switch the attenuator not until reaching 50 dB under full scale, since the linearity errors are very small in this range.</p>
<p>Test setup</p>	<ul style="list-style-type: none"> ➤ Connect the spectrum analyzer to the RF output of the DUT with hermetically sealed RF measurement cables.
<p>Measurement</p>	<ul style="list-style-type: none"> ➤ Settings on DUT Frequency recommended test frequencies Level +13 dBm, unmodulated ➤ Setting on the analyzer Test frequency SPAN 10 Hz FILTER TYPE FFT RES BW 5 Hz set Marker to test frequency Reference level $P_{ref} = +15$ dBm ➤ Read the marker level P_{Marker} and calculate the correction factor $C = P_{absolute} - P_{Marker}$ with $P_{absolute}$ from the measurements performed with the power meter. ➤ Now decrease the DUT level in 5 dB steps and calculate the output power P by adding the Correction factor C to the marker readout. ➤ As soon as the marker level P_{Att1} is lower than $P_{ref} -45$ dB increase the sensitivity of the analyzer by reducing the input attenuation, switching on the internal preamplifier if available and reducing the resolution bandwidth to 1 Hz for levels below -90 dBm. Set the analyzer reference level to $P_{Att1} + 1$ dB. After switching the analyzer sensitivity read out the marker level P_{Att2} and recalculate the Correction factor: $C_{new} = C_{old} + P_{Att1} - P_{Att2}$ ➤ Continue the measurement down to -120 dBm in 5 dB steps.
<p>Recommended test frequencies.</p>	<p>1 MHz, 512.5 MHz, 1087.5 MHz, 2187.5 MHz, 3187.5 MHz</p>

Output Impedance

Test assembly	" Test Assembly for Output Impedance (VSWR) " (page 1.5)
Test method	For the VSWR measurement of a source the effect of the level control must be taken into account. For this purpose, an auxiliary generator is used which transmits a wave with a slightly offset carrier frequency into the DUT. The difference frequency has to be within the control bandwidth of the level control. In the case of ideal source impedance, the wave from the auxiliary generator is not reflected by the DUT. In the case of not ideal DUT source impedance, the output wave of the DUT and the reflected wave of the auxiliary generator are superimposed on one another. A directional coupler couples a part of these outgoing superimposed waves to an analyzer. The frequency offset, results in a beat of the superimposed outgoing waves. The VSWR is the ratio between the maximum and minimum amplitude of the beat.
Measurement	<ul style="list-style-type: none"> ➤ Settings on DUT: <ul style="list-style-type: none"> - Level: test level - Frequency: test frequency, unmodulated ➤ Settings on spectrum analyzer: <ul style="list-style-type: none"> - Test frequency, span 0 Hz, test level - Resolution and video bandwidth 10 kHz - Linear level scale - Sweep time 20 ms ➤ Settings on second signal generator: <ul style="list-style-type: none"> - set the frequency to the test frequency – 100 Hz, - set minimum level, unmodulated. ➤ Vary the reference level to bring the line displayed on the screen of the spectrum analyzer approximately into the middle of the screen. Measure the voltage of the signal V_{ref}. ➤ Unscrew the VSWR bridge from the DUT and let the test port open. Increase the level of the second signal generator until the voltage on the analyzer is $V_{ref} \pm 0.5 \%$. ➤ Screw the VSWR bridge onto the DUT again. ➤ Measure the maximum voltage V_{max} and minimum voltage V_{min} of the sinusoidal trace. Calculate the VSWR: $VSWR = V_{max}/V_{min}$
Recommended test frequencies and levels	<ul style="list-style-type: none"> ➤ Test frequencies: from 200 kHz every 50 MHz up to RF_{max}. ➤ Test levels: +0 dBm and +13 dBm.

Setting Time (only for Option R&S SMC-K4)

Test assembly	Connect the spectrum analyzer (Table 1-1 , item 18) to the RF connector of the DUT.						
Test method	The spectrum analyzer is operated as a fast level meter in zero span. A controller transfers the start and the stop level via the IEC/IEEE bus. The analyzer is triggered by the positive edge on the EOI line of the IEC/IEEE bus. At switch over from start to stop level, the settling procedure is displayed on the screen of the analyzer.						
Preparation of measurement	<ul style="list-style-type: none"> ➤ Synchronize the reference frequencies of the DUT and the analyzer. ➤ Make IEC/IEEE bus and RF connections. ➤ Connect spectrum analyzers trigger connector to EOI line (pin 5) of IEC/IEEE bus. ➤ Setting on DUT: <ul style="list-style-type: none"> - Frequency: test frequency unmodulated, - Level: start level ➤ Settings on spectrum analyzer: <ul style="list-style-type: none"> - REFERENCE LEVEL: target level + 3 dB - AMPLITUDE LOG RANGE 10 dB - RESOLUTION BANDWIDTH 200 kHz - VIDEO BANDWIDTH 2 MHz - SPAN 0 Hz - SWEEP TIME: 10 ms - TRIGGER EXTERN - External triggering by positive edge at 1.4 V. 						
Measurement	<ul style="list-style-type: none"> ➤ Send the stop level from the controller to the DUT. <ul style="list-style-type: none"> ⇒ The externally triggered analyzer displays the settling curve. The setting time is defined as the time from which on the level deviation from the final level is less than the specified deviation in the data sheet. ➤ Measure the following steps with ALC state AUTO and with ALC state OFF (Sample & Hold). 						
Recommended test frequencies and levels	<p>Frequencies: 1 MHz, 30 MHz, 375 MHz, 1.1 GHz, 2.2 GHz and 3.2 GHz</p> <table border="1" data-bbox="576 1549 1353 1676"> <thead> <tr> <th data-bbox="576 1549 963 1591">Start level</th> <th data-bbox="963 1549 1353 1591">Stop level</th> </tr> </thead> <tbody> <tr> <td data-bbox="576 1591 963 1634">-120 dBm</td> <td data-bbox="963 1591 1353 1634">+13 dBm</td> </tr> <tr> <td data-bbox="576 1634 963 1676">-35 dBm</td> <td data-bbox="963 1634 1353 1676">-5 dBm</td> </tr> </tbody> </table>	Start level	Stop level	-120 dBm	+13 dBm	-35 dBm	-5 dBm
Start level	Stop level						
-120 dBm	+13 dBm						
-35 dBm	-5 dBm						

Internal Modulation Generator

Frequency accuracy

The LF-Generator is integrated into an FPGA clocked with the same reference frequency as the synthesizer. Therefore, the LF frequency has the same accuracy as the RF and has not to be measured.

Distortions

Test equipment	Spectrum analyzer (Table 1-1 , item 18)
Test method	The fundamental and harmonics of the LF-generator are measured with the analyzer. The analyzer calculates the Total Harmonic Distortion with the 'Harmonic Distortion' function.
Test setup	➤ Connect the spectrum analyzer to the LF socket of the DUT.
Measurement of frequency settings and distortion	<ul style="list-style-type: none"> ➤ Settings on DUT: LF Output menu: LF Gen Voltage 1 V LF Gen Frequency 1 kHz ➤ Settings of the spectrum analyzer: RF INPUT DC AMPT REF LEVEL 20 dBm FREQ CENTER = LF Gen Frequency MEAS ⇔ HARMONIC DISTOR RF ATTEN MANUAL increase by 10 dB ➤ Read the THD ➤ Repeat the measurement at the recommended test frequencies by changing the DUT LF Gen Frequency and the analyzer center frequency.
Recommended test frequencies	1 kHz, 10 kHz

Level Accuracy and Frequency response

Test equipment	AC voltmeter (<i>Table 1-1</i> , item 14)
Test method	The output level of the LF Generator is measured direct with an AC voltmeter.
Test setup	➤ Connect the AC voltmeter to the LF socket of the DUT.
Measurement of Level Accuracy	➤ Settings on DUT: LF Output menu: LF Gen Frequency 1 kHz set LF Output Voltage to recommended levels and measure the output level
Recommended test levels for Level Accuracy	10 mV, 30 mV, 100 mV, 300 mV, 1 V and 2.55 V
Measurement	➤ Settings on DUT: LF Output menu: LF Output Voltage 1 V set LF Gen Frequency to recommended test frequencies and measure the output level ⇒ Determine the highest and the lowest level V_{max} and V_{min} . The frequency response in dB is defined as: $D = 20 \cdot \log_{10}(V_{max}) - 20 \cdot \log_{10}(V_{min})$
Recommended test frequencies	10 Hz, 1 kHz, 10 kHz, 100 kHz

Note: *The settling time is a pure computer time and needs therefore not to be measured.*

Amplitude Modulation

AM Setting Uncertainty

Test assembly	See section " Standard Test Assembly for Analog Modulations ", page 1.3.
Measurement of accuracy versus modulation depth	<ul style="list-style-type: none"> ➤ Settings on DUT: <ul style="list-style-type: none"> RF On Frequency 150 MHz Level: 0 dBm Amplitude Modulation On AM Source Internal LF Gen Frequency 1 kHz ➤ Settings on analyzer: <ul style="list-style-type: none"> AMPTD ⇨ REF LEVEL test level + 6 dB , FREQ ⇨ CENTER 150 MHz FM DEMOD, FMDEMOD ON, RESULT DISPLAY ⇨ AM DEMOD BW 50 kHz RANGE ⇨ DEVIATION PER DIV 20 % MEAS TIME 100 ms ➤ set the AM Depth to the recommended modulation depths and read the modulation depth $\pm\text{peak}/2$ from the analyzer. ➤ set DUT to <ul style="list-style-type: none"> AM Source External, AM Ext Coupling AC, AM Depth 80%, LF Gen Output On, Connect LF output to MOD EXT input and read the modulation depth $\pm\text{peak}/2$ from the analyzer.
Recommended modulation depths	m = 5%, 10 %, 20 %, 40 %, 60 %, 80 %

<p>Measurement of accuracy versus RF</p>	<ul style="list-style-type: none"> ➤ Settings on DUT: RF On Frequency recommended test frequencies Level: 0 dBm Amplitude Modulation On AM Source Internal LF Gen Frequency 1 kHz AM Depth 80 % ➤ Settings on analyzer: AMPTD ⇨ REF LEVEL 6 dBm, FREQ ⇨ CENTER same as DUT FM DEMOD, FMDEMODOFF RESULT DISPLAY ⇨ AM DEMODOFF BW 50 kHz RANGE ⇨ DEVIATION PER DIV 20 % MEAS TIME 100 ms ➤ measure the modulation depth for all recommended test frequencies
<p>Recommended test frequencies</p>	<p>100 kHz, 1MHz, 23.4375 MHz, 23.438 MHz, 99.9 MHz, 399.9 MHz, 1100 MHz, 1599.9 MHz, 1600.1 MHz, 2262.9 MHz, 3200 MHz</p>

AM Distortion

Test assembly	See section " Standard Test Assembly for Analog Modulations ", page 1.3.
Measurement	<ul style="list-style-type: none"> ➤ Settings on DUT: RF On Level 0 dBm Amplitude Modulation menu: LF Gen Frequency 1 kHz Source Internal AM depth 30%. ➤ Settings on R&S FSQ: AMPTD / REF LEVEL 6 dBm, FREQ / CENTER test frequency FM DEMOD, FMDEMOD ON, RESULT DISPLAY ⇒ AM RESULT DISPLAY ⇒ AF SPECTRUM DEMOD BW > 7* f_{mod}, RANGE ⇒ DEVIATION PER DIV 20 % MEAS TIME 0.16 s ➤ Measure the THD for all recommended test frequencies. To convert the displayed THD value in dB to percent calculate: $THD_{pct} = 100 * 10^{(THD_{dB}/20)}$. Limits according datasheet
Recommended test frequencies	<ul style="list-style-type: none"> ➤ 100 kHz, 1MHz, 23.4375 MHz, 23.438 MHz, 99.9 MHz, 399.9 MHz, 1100 MHz, 1599.9 MHz, 1600.1 MHz, 2262.9 MHz, 3200 MHz

AM Frequency Response

Test assembly	See section " Standard Test Assembly for Analog Modulations ", page 1.3.												
Measurement	<ul style="list-style-type: none"> ➤ Settings on DUT: RF On Level 0 dBm Amplitude Modulation menu: Source External External Coupling DC AM depth 60%. ➤ Settings on R&S FSQ: AMPTD / REF LEVEL 6 dBm FREQ / CENTER test frequency FM DEMOD, FMDEMOD ON, RESULT DISPLAY ⇒ AM RESULT DISPLAY ⇒ AF SPECTRUM DEMOD BW 200 kHz, RANGE ⇒ DEVIATION PER DIV 20 % MEAS TIME ≥ 16/fmod s ➤ Vary the carrier frequency from 1 MHz to RF_{max}. Recommended test frequencies 1 MHz, 99.9 MHz, 399.9 MHz, 799.9 MHz, 1100 MHz, 1599.9 MHz, 1600.1 MHz, 3200 MHz. ➤ Settings on the signal generator: - LF Output ON - LFGen Voltage 1 V (V_{peak}). ➤ Set the generator frequency to the frequencies given below and measure the modulation depth in RMS. <table border="1" data-bbox="576 1225 1362 1310" style="width: 100%; border-collapse: collapse; text-align: center;"> <tr> <td style="padding: 2px;">Gen. frequency</td> <td style="padding: 2px;">10 Hz</td> <td style="padding: 2px;">100 Hz</td> <td style="padding: 2px;">1 kHz</td> <td style="padding: 2px;">10 kHz</td> <td style="padding: 2px;">50 kHz</td> </tr> <tr> <td style="padding: 2px;">MEAS TIME</td> <td style="padding: 2px;">1.6 s</td> <td style="padding: 2px;">0.2 s</td> <td style="padding: 2px;">0.2 s</td> <td style="padding: 2px;">0.2 s</td> <td style="padding: 2px;">0.2 s</td> </tr> </table> <p style="margin-left: 20px;">⇒ The modulation frequency response in dB is the difference between the greatest and the smallest modulation depth m_{max} and m_{min}:</p> $m_{\max-\min} = 20 * \log_{10}(m_{\max}) - 20 * \log_{10}(m_{\min})$	Gen. frequency	10 Hz	100 Hz	1 kHz	10 kHz	50 kHz	MEAS TIME	1.6 s	0.2 s	0.2 s	0.2 s	0.2 s
Gen. frequency	10 Hz	100 Hz	1 kHz	10 kHz	50 kHz								
MEAS TIME	1.6 s	0.2 s	0.2 s	0.2 s	0.2 s								
	<ul style="list-style-type: none"> ➤ Repeat the measurement at RF = 1 GHz with the setting Amplitude Modulation ⇒ External Coupling AC ➤ Repeat the measurement at RF = 1 GHz with the internal modulation generator with the setting Amplitude Modulation ⇒ Source Internal. 												

Synchronous PhiM with AM

Test assembly	See section " Standard Test Assembly for Analog Modulations ", page 1.3.
Measurement	<ul style="list-style-type: none"> ➤ Settings on DUT: <ul style="list-style-type: none"> RF On Level PEP = P_{\max} 0 dBm Amplitude Modulation menu: <ul style="list-style-type: none"> LF Gen Frequency 1 kHz Source Internal AM depth 30%. ➤ Settings on spectrum analyzer <ul style="list-style-type: none"> AMPTD / REF LEVEL 3 dBm, FM DEMOD DEMOD BW 12.5 kHz MEAS TIME 100 ms RESULT DISPLAY ⇨ PM ➤ Recommended test frequencies: <ul style="list-style-type: none"> 23.4375 MHz, 99.9 MHz, 399.9 MHz, 799.9 MHz, 1100 MHz, 1599.9 MHz, 1600.1 MHz, 2262.9 MHz, 3200 MHz <p>Limits according datasheet</p> <ul style="list-style-type: none"> ➤ Measure the resulting phase modulation with peak detection (\pmpeak/2-value).

Frequency Modulation

Test Methods

Test assembly	See section " Standard Test Assembly for Analog Modulations ", page 1.3.
Test Method "FFT Demodulation (Option FS-K7)"	<p>The FM deviation and distortion are determined by digital signal processing in the spectrum analyzer.</p> <ul style="list-style-type: none"> ➤ Settings on R&S FSQ: <ul style="list-style-type: none"> AMPTD / REF LEVEL test level, FREQ / CENTER test frequency FMDEMOM, FMDEMOM ON, RESULT DISPLAY / FM resp. PM DEMOM BW > 2 * (deviation + fmod) for FM, DEMOM BW > 2 * fmod * (1 + deviation) for PM, RANGE / DEVIATION PER DIV 0.5 * deviation MEAS TIME 3/fmod for distortion (up to 3rd harmonic) <ul style="list-style-type: none"> RESULT DISPLAY / FM resp. PM / AF SPECTRUM DEMOM BW > 2 * (deviation + 3.5 * fmod) for FM, DEMOM BW > 7 * fmod * (1 + deviation) for PM, MEAS TIME 16/fmod

FM Setting Uncertainty

Test Method	➤ FFT Demodulation (see chapter " Test Methods ")
Measurement	<ul style="list-style-type: none"> ➤ Settings on DUT: <ul style="list-style-type: none"> RF On Level 0 dBm: Frequency Modulation menu: State on FM Source Internal
Recommended settings	<ul style="list-style-type: none"> ➤ Recommended test frequencies: 10 MHz, 1000 MHz with LFGen Freq = 1 kHz, FM Deviation = 100 kHz ➤ Repeat measurement at 1000 MHz with changing settings to <ul style="list-style-type: none"> FM Source External FM Ext Coupling AC <p>feed in a 1 kHz, 1Vp external modulation signal at the MOD EXT connector</p>

FM Distortion

Test Method	FFT Demodulation (see chapter " Test Methods ")
Measurement	<ul style="list-style-type: none"> ➤ Settings on DUT: RF On Level 0 dBm: Frequency Modulation menu: State on FM Source Internal LFGen Frequency 2 kHz. ➤ Settings on R&S FSQ: DEMOD BW 5 * FM deviation, RANGE / DEVIATION PER DIV 250 kHz, RESULT DISPLAY / FM, AF SPECTRUM, SWEEP / MEAS TIME 50 ms, FREQ / AF STOP 50 kHz. ➤ Read the THD from the display. To convert to percent calculate $THD_{pct} = 100 * 10^{(THD_{dB}/20)}$.
Recommended settings	<ul style="list-style-type: none"> ➤ CF sweep Recommended test frequencies with FM deviation 250 kHz: 10 MHz, with FM deviation 500 kHz: 400.1 MHz, 533 MHz, 667 MHz, 800 MHz, with FM deviation 1 MHz: 1100 MHz, with FM deviation 2 MHz: 3200 MHz

FM Frequency Response

Test Method	FFT Demodulation (see chapter " Test Methods ")
Measurement	<ul style="list-style-type: none"> ➤ Settings on DUT: RF On Level 0 dBm Frequency 23 MHz Frequency Modulation menu: FM Source External FM Ext Coupling DC FM deviation: 100 kHz ➤ Setting on the signal generator: The internal LF generator of the signal generator delivers the modulation signal to the external modulation input of the DUT. The level of the modulation signal is controlled by use of an AC voltmeter (Item 14 of Table 1-1). - LFGGen Voltage 1 V peak - State ON ➤ Settings on R&S FSQ: FFT Demodulation ➤ Vary the signal generator frequency and measure the modulation deviation. ⇒ The modulation frequency response is the factor between the greatest and the smallest modulation deviation.
Recommended settings	<ul style="list-style-type: none"> ➤ LF in logarithmic steps, 3 steps per decade (1, 2, 5) from 10 Hz to 100 kHz ➤ Perform the measurement for test frequency 23 MHz. ➤ Repeat the measurement with changing the settings to FM Ext Coupling AC for test frequency 23 MHz. ➤ Repeat the measurement with changing the settings to FM Ext Coupling AC FM deviation: 500 kHz for test frequencies: 200.1 MHz, 266 MHz, 333 MHz, 400 MHz. LF sweep from 1 kHz to 100 kHz ➤ Repeat the measurement with changing the settings to FM Source Internal FM deviation: 500 kHz at test frequency 400 MHz. LF sweep from 1 kHz to 100 kHz

Synchronous AM with FM

Test assembly	See section " Standard Test Assembly for Analog Modulations ", page 1.3.
---------------	--

<p>Measurement</p>	<ul style="list-style-type: none"> ➤ Settings on DUT: RF On Level 0 dBm Frequency Modulation menu: State on FM Source Internal FM deviation 40 kHz LFGen Frequency 1 kHz. ➤ Settings on spectrum analyzer AMPTD / REF LEVEL 6 dBm FREQ / CENTER test frequency FMDEMOD, FMDEMOD ON, RESULT DISPLAY / AM / AF Spectrum AF Start = 0 Hz AF Stop = 5 kHz RES BW = 30 Hz DEMODO BW = 100 kHz IF BW MANUAL 10 MHz, RANGE / REFERENCE VALUE 0.2 % MEAS TIME 3 ms ➤ Read the AM depth at 1 kHz modulation frequency from the demodulated AF spectrum.
<p>Recommended settings</p>	<ul style="list-style-type: none"> ➤ CF sweep Recommended test frequencies: 23.4 MHz, 400 MHz, 800 MHz, 1100 MHz, 3200 MHz

Carrier Frequency Offset with FM

Test assembly	See section " Standard Test Assembly for Analog Modulations ", page 1.3.
Measurement	<ul style="list-style-type: none"> ➤ Settings on DUT: <ul style="list-style-type: none"> RF On Level 0 dBm Frequency 1 GHz Frequency Modulation menu: State on FM Source Internal FM deviation 1 MHz LFGen Frequency 10 kHz. ➤ Settings on spectrum analyzer <ul style="list-style-type: none"> AMPT / REF LEVEL 0 dBm FREQ / CENTER 1 GHz SPAN 10 kHz MKR / SIGNAL COUNT / NEXT / CNT RESOL 10 Hz ➤ Terminate the DUT External Modulation input with 50 Ω and execute the internal FM offset adjustment. ➤ Execute a single sweep. Using MKR→ / PEAK, read counted marker frequency. <ul style="list-style-type: none"> ⇒ The offset is the difference between marker frequency and set carrier frequency. ➤ Repeat measurement with FM source external, coupling ac and dc (2 measurements).

Phase Modulation

PhiM Setting Uncertainty

Test Method	FFT Demodulation (see chapter " Test Methods ").
Measurement	<ul style="list-style-type: none"> ➤ Settings on DUT: RF On Level 0 dBm Phase Modulation menu: State on PhiM Source Internal PhiM Deviation 2.5 rad LFGen Freq = 1 kHz ➤ Settings on spectrum analyzer: see chapter "Test Methods"
Recommended settings	<ul style="list-style-type: none"> ➤ Recommended test frequencies: 10 MHz and 400 MHz ➤ Repeat measurement at 400 MHz with changing settings to PhiM Source External PhiM Ext Coupling AC feed in a 1 kHz external modulation signal at MOD EXT connector

PhiM Distortion

Test Method	FFT Demodulation (see chapter " Test Methods ")
Measurement	<ul style="list-style-type: none"> ➤ Settings on DUT: RF On Level 0 dBm Phase Modulation menu: State on PhiM Source Internal LFGGen Frequency 10 kHz ➤ Settings on R&S FSQ: see chapter "Test Methods" SWEEP / MEAS TIME 50 ms, FREQ / AF STOP 50 kHz, AMPTD / REF LEVEL 0 dBm, FREQ / CENTER test frequency. ➤ Read THD from the Display. To convert to percent calculate $THD_{pct} = 100 * 10^{(THD_{dB}/20)}$.
Recommended settings	<ul style="list-style-type: none"> ➤ CF sweep Recommended test frequencies with PhiM deviation 2.5 rad: 10 MHz, with PhiM deviation 5 rad: 400.1 MHz, 533 MHz, 667 MHz, 800 MHz, with PhiM deviation 10 rad: 1100 MHz, with PhiM deviation 20 rad: 3200 MHz

PhiM Frequency Response

Test method	FFT Demodulation (see chapter " Test Methods ").
Measurement	<ul style="list-style-type: none"> ➤ Settings on DUT: <ul style="list-style-type: none"> RF On Level 0 dBm Phase Modulation menu: <ul style="list-style-type: none"> PhiM Source External PhiM Ext Coupling DC PhiM deviation: 5 rad ➤ Setting on the signal generator: <p>The internal LF generator of the signal generator delivers the modulation signal to the external modulation input of the DUT. The level of the modulation signal is controlled by use of an AC voltmeter (Item 14 of Table 1-1).</p> <ul style="list-style-type: none"> - LFGGen Voltage 1 V peak - State ON ➤ Settings on R&S FSQ: <ul style="list-style-type: none"> FFT Demodulation ➤ Vary the signal generator frequency and measure the modulation deviation. ⇒ The modulation frequency response is the factor between the greatest and the smallest modulation deviation.
Recommended settings	<ul style="list-style-type: none"> ➤ LF in logarithmic steps, 3 steps per decade (1, 2, 5) from 10 Hz to 100 kHz ➤ Perform the measurement for test frequency 23 MHz ➤ Repeat the measurement with changing the settings to PhiM Ext Coupling AC for test frequency 23 MHz. ➤ Repeat the measurement with changing the settings to PhiM Ext Coupling AC for test frequencies: 200.1 MHz, 266 MHz, 333 MHz, 400 MHz. LF sweep from 1 kHz to 100 kHz ➤ Repeat the measurement with changing the settings to PhiM Source Internal PhiM deviation 5 rad at test frequency 400 MHz. LF sweep from 1 kHz to 100 kHz

Pulse Modulation

ON/OFF Ratio

Test equipment	<ul style="list-style-type: none"> - Spectrum analyzer (Table 1-1, item 18) - Pulse generator (Table 1-1, item 13)
Test setup	<ul style="list-style-type: none"> ➤ To determine the ON/OFF ratio, connect the spectrum analyzer to the RF output socket of the DUT and let the PULSE EXT input open.
Measurement	<ul style="list-style-type: none"> ➤ Setting on DUT: <ul style="list-style-type: none"> RF On Level 0 dBm Frequency recommended test frequencies Pulse Modulation menu: <ul style="list-style-type: none"> Source External State On Polarity Inverse ➤ Setting on Analyzer <ul style="list-style-type: none"> FREQ/CENTER test frequency SPAN 0 Hz AMPT/REF LEVEL 0 dBm BW ⇒ RES BW MANUAL 3 kHz SWEEP ⇒ SWEEP TIME MANUAL 100 ms MEAS ⇒ TIME DOM POWER on ➤ Determine the output level of the DUT at the recommended test frequencies with <ul style="list-style-type: none"> Pulse Modulation ⇒ Polarity Inverse and Pulse Modulation ⇒ Polarity Normal. <ul style="list-style-type: none"> ⇒ The level difference between the output level with Polarity Inverse and Polarity Normal is the ON/OFF ratio.
Recommended test frequencies	5 MHz, 150 MHz, 400 MHz, 1.1 GHz, 2.2 GHz, 3 GHz, 3.2 GHz

Rise/ Fall Time

Test assembly	" Test Assembly for Pulse Modulation " (see page 1.3)
Test method	The RF signal is down converted to 0 Hz in phase. Thus, the IF output reproduces the RF amplitude vs. time.
Measurement	<ul style="list-style-type: none"> ➤ Setting on pulse generator: For adjustment statically high level, for measurement square wave pulse sequence with a frequency of 0.5 MHz, TTL level ➤ Setting on DUT: RF On Level 0 dBm Frequency recommended test frequencies Pulse Modulation menu: State On ➤ Setting on Signal Generator: RF On Level Recommended Lo-Level of Mixer Frequency same as DUT ➤ Setting on oscilloscope: Adjust V/div according to the mixer in use Time base 20 ns/div Trigger: - for adjustment free running, - for measurement 50 % of signal amplitude, rising and falling edge. ➤ Adjustment: At each test frequency adjust phase using menu RF Mod / Frequency/Phase / Phase Settings. Vary the Delta Phase to obtain maximal signal output at the mixers IF port. The voltage at maximum corresponds to 100 % of RF amplitude. ➤ Measurement: Evaluate the down converted pulse-modulated signal on the oscilloscope. <p style="margin-left: 40px;">⇒ Rise time = time between 10% and 90% of signal amplitude Fall time = time between 90% and 10% of signal amplitude</p>
Recommended test frequencies	400 MHz, 1.1 GHz, 2.2 GHz, 3.2 GHz

Video Crosstalk

Test assembly	As above for ON/OFF Ratio
Measurement	<ul style="list-style-type: none"> ➤ Setting on pulse generator: Square wave pulse sequence with a frequency of 100 kHz, TTL level ➤ Setting on DUT: RF On Frequency 1 GHz, 6 GHz Level 0 dBm Pulse Modulation State On ➤ Settings on the Analyzer REF LEVEL 0 dBm FREQ CENTER 100 kHz SPAN 10 kHz ➤ Measure the signal level at 100 kHz with the analyzer. <ul style="list-style-type: none"> ⇒ The Video Crosstalk is the amplitude of the spectral line found at 100 kHz related to the RF carrier level

Pulse Generator

PULSE VIDEO

Test equipment	- Storage oscilloscope (Table 1-1 , item 3) with 50 Ω Feed-through termination on input.
Test setup	➤ Connect the PULSE VIDEO socket on the rear of the DUT to the storage oscilloscope.
Measurement	<p>Setting on DUT:</p> <p>Pulse Modulation menu: State On Source: Pulse Generator</p> <p>Pulse Generator menu: State On Pulse Period 10 μs Pulse Width 5 μs</p> <p>➤ Setting on oscilloscope: 1 V/div Time base 2.5 μs/div Trigger: 50 % of amplitude, rising edge.</p> <p>➤ Check the signal for a symmetric square wave with 10 μs pulse period and 1.5 V amplitude. Rise and fall time < 10 ns</p>

Contents - Chapter 2 "Procedures after Module Replacement"

- 2 Procedures after Module Replacement.....2.1**
 - Procedures after Replacing the Basis Board2.2**
 - Adjustments2.2**
 - Internal Adjustments2.2
 - Adjustments of the Complete Unit.....2.2
 - External Adjustments Requiring Measurement Equipment2.2
 - External Level Correction2.3
 - Recalibration2.3
 - Adjustment of internal Reference Frequency.....2.4
 - Recalibration2.4
 - Internal Self Test.....2.4**

2 Procedures after Module Replacement

This chapter describes all necessary measures to restore the performance of the R&S SMC after module replacement.

There are no manual adjustments to be performed. Internal and external adjustment routines are implemented for this purpose.

Spare part RF boards are tested at Rohde & Schwarz with calibrated working standards according to the performance test. All measurement values are within the specified values including the measurement uncertainty as a minimum guard band. Power levels are corrected to nearly ideal values. When installing a spare part RF board the only difference at the RF side is the connecting cable between the RF board and the front panel. When testing the RF boards Rohde & Schwarz uses the same type of cable as it is installed in the R&S SMC.

OCXOs are tested at Rohde & Schwarz for the frequency adjustment range and the control voltage for an exact 10 MHz output frequency. This control voltage is coded in a digital value and stored on the OCXO module. In the R&S SMC the digital value is read from the OCXO module.

The probability that the R&S SMC meets its specifications after the replacement of a RF board and / or an OCXO is very high. To increase this probability even further and to detect a defective connecting cable between the RF board and the front panel Rohde & Schwarz recommends to adjust and to verify the power level and the reference frequency according to the instructions in the table below

If a calibration of the instrument is strictly necessary the performance test should be performed completely.

After replacing an assembly, check the following table to see which service procedure you perform.

Changed module	Required adjustment/correction	Recommended Test Procedure (refer to chapter 1 Performance Test "Checking the rated characteristics")
Basis Board	Setup/Internal Adjustments/Adjust All	None
RF Board	Setup/Internal Adjustments/Adjust All External Level Correction (power meter and special measuring software required)	Level Data at 0 dBm
OCXO	Setup/Internal Adjustments/Adjust All	Reference Frequency "Output of Internal Reference"
Power Supply	Setup/Internal Adjustments/Adjust All	None

Procedures after Replacing the Basis Board

Required equipment

USB Memory Stick (at least 128 MB)

Required software:

Actual SMC_Firmware see R&S homepage www.rohde-schwarz.com

Copy the firmware to the root folder of the memory stick.

Install the new Firmware

See Chapter 4 "Software Update".

Adjustments

Preliminary Remark

Setting a defined initial state by pressing the **PRESET** key prior to adjustments is recommended. To ensure that the internal adjustments are valid at operating temperature, at least **20 minutes warm-up time** at this temperature must be observed.

Internal Adjustments

All internal adjustments are available in the **Setup/Internal Adjustments** menu (see operating manual).

Adjustments of the Complete Unit

Performing **Setup/Internal Adjustments/Adjust All** activates all internal adjustments in a reasonable order.

The external adjustments have to be performed, if the recommended calibration interval is exhausted or the RF Board has been replaced.

External Adjustments Requiring Measurement Equipment

The external adjustments require calibrated equipment and special software. Data sheet specifications of the unit are concerned. If required, contact your local Rohde & Schwarz representative.

External Level Correction

External level correction measures output power over frequency and level and stores the correction values inside the instrument to maintain level accuracy. The R&S SMC provides a build in measuring procedure for external level correction.

NOTICE

Risk of damage to the power sensor

Power sensor NRP-Z91 can be damaged when being exposed to R&S SMCs maximum output power. So it is recommended to PRESET the instrument before connecting the power sensor. The build-in level correction procedure does not overload the sensor.

Recalibration

Test equipment

- R&S NRP-Z91 or R&S NRP-Z92 power sensor with NRP-Z3 or NRP-Z4 USB adaptor

Test setup

- Power on instrument
- Setting on instrument:

PRESET

Setup Menu

Reference Oscillator

Source INTERNAL

Protection

Protection Level 2 = 147946 ENTER

- Connect the power sensor to the RF plug and to the USB connector of the instrument.
- Allow the R&S SMC and the power sensor to warm up for at least 20 minutes

Adjustment

- Setting on instrument:

Setup Menu

Internal Adjustments

Adjust Ext Level...

ECEXUTE

Adjustment Data CUSTOM

Note that the R&S factory level correction data is not replaced by this procedure, instead an additional data set is created.

The active correction data set is selected by the setting "Adjustment data"

Adjustment of internal Reference Frequency

The frequency accuracy of the synthesizer is determined (set to internal reference) by a 20 MHz VTCXO or when the Option R&S SMC-B1 is fitted with a highly stable OCXO that is set to a calibrated frequency standard at the R&S factory. This oscillator is subject to ageing and can be recalibrated.

Recalibration

Important: Allow the DUT to warm up for at least 20 minutes before adjustment is executed

- | | |
|----------------|--|
| Test equipment | - External frequency counter (1 Hz to RF_{max} , resolution 0.1 Hz) |
| Test setup | ➤ Connect a calibrated external frequency counter to the reference output at the rear panel. |
| Adjustment | ➤ Setting on DUT: |

PRESET

Setup Menu

Protection

Protection Level 2 = 147946 ENTER

- Setting on spectrum analyzer (external frequency counter):

MKR SIGNAL COUNT

MKR / NEXT CNT RESOL 0.1 Hz

- Adjust the TCXO/ OCXO Calibration Value (Setup - Reference Oscillator - Calibration Value) for an external frequency counter reading of 10 MHz, with minimal error.
- Press Write **value to Eeprom** to store the DAC value.

Internal Self Test

After each module replacement, it is recommended to perform the internal self test (refer to chapter 3, "Troubleshooting with Internal Self Test"). The self test checks the instrument by measuring internal diagnostic points and verifies whether generator is operating properly.

If a self test failure occurs, check again whether all cables are properly connected. If the self test fails continuously, contact your local service center.

Contents – Chapter 3 "Repair"

3 Repair	3.1
Purpose	3.1
Instrument Design and Function Description	3.1
RF Board	3.3
Internal and external 10 MHz reference	3.3
TCXO 20 MHz crystal oscillator	3.3
RF Synthesizer/DDS	3.3
Harmonics filters	3.4
LF generator	3.4
Pulse generator and Pulse Modulator	3.4
Modulation matrix and AM/FM/φM modulator	3.4
AM modulators	3.4
Automatic Level control.....	3.4
Step Attenuator and reverse power protection	3.5
Supply voltage control and filtering	3.5
Power Supply Module	3.5
Basis Board	3.5
Fuses	3.5
Switching regulators.....	3.6
Controller	3.6
FPGA (SMB_COM).....	3.6
Keyboard Controller	3.6
Diagnostic ADC.....	3.6
EEPROM	3.6
SIM Card.....	3.6
Temperature sensor.....	3.6
Fan Controller	3.6
Troubleshooting	3.7
Measuring Equipment and Accessories.....	3.7
Switch-On Problems	3.8
Switch-on	3.8
Switch-off	3.8
Problems with Booting	3.11
Keyboard and Rotary Knob Test.....	3.12
Troubleshooting with Internal Self Test.....	3.13
Troubleshooting with Internal Test Points	3.14
Troubleshooting with Internal Adjustments	3.16
Instrument Faults	3.17
Troubleshooting – Basis Board Module	3.21
Supply Voltages	3.21
Fuses	3.22
Troubleshooting – RF Board module	3.23
Supply Voltages	3.23
Control Signals.....	3.24
Internal Input and Output Signals	3.25
Error Messages Concerning the RF Board Module.....	3.26
Warnings Concerning the RF Board Module	3.26
Frequency Error	3.27

Troubleshooting – Reference Oscillator option R&S SMC-B1	3.28
Input and Output Signals	3.28
Error Messages Concerning the Reference Oscillator Module	3.29
Frequency Error, Reference Oscillator Adjustment.....	3.29
Module Replacement	3.30
Required tools	3.30
Overview of the Modules.....	3.30
After replacing an assembly.....	3.31
Safety Instruction	3.32
Dismounting the tube	3.33
Mounting the tube	3.33
Replacing Fuse	3.34
Installing Fuse	3.34
Replacing the Front Unit (A300)	3.35
Removing the Front Unit A300 (1411.4802.02).....	3.35
Install the Front Unit A300 (1411.4802.02).....	3.37
Replacing the TFT Display (A330), Encoder Board (A310), Flex. Switch Board, Pushbutton Board Set, the key frame and front corner plate.....	3.39
Removing the TFT Display A330.....	3.39
Removing the flex. switch Board, the Pushbutton-Set and the key frame	3.40
Removing the Encoder Board A310	3.41
Removing the front corner plate	3.41
Install the Flex. switch Board, the Pushbutton Set, the key frame and the TFT Display A330	3.42
Install the Encoder Board A310	3.44
Install the front corner plate	3.45
Replacing the Power Supply A50	3.46
Removing the Power Supply A50	3.46
Install the Power Supply A50.....	3.47
Replacing the Basis Board 2 (A100).....	3.48
Removing the Basis Board 2	3.48
Installing the Basis Board 2	3.50
Replacing the SIM Card A110	3.51
Replacing the RF-Board (A200).....	3.52
Removing the RF-Board	3.52
Installing the RF-Board	3.53
Replacing the Fan Unit (E1).....	3.55
Removing the Fan Unit (E1).....	3.55
Install the Fan Unit (E1)	3.55
Replacing the R&S SMC-B1	3.56
Install the R&S SMC-B1.....	3.56
Remove the Reference Oscillator R&S SMC-B1.....	3.57

3 Repair

Purpose

NOTICE **Validity**

- This version of the document describes the instrument R&S SMC100A starting with Serial Number 102000.
- It differs from former versions in a new front unit caused by a new TFT display.
- For service purposes the front unit can be replaced by the new version in all instruments with a Basis Board with the Change Index 04.00 or higher.

Instrument Design and Function Description

A schematic of the signal generator's design is presented below as block diagram at module level

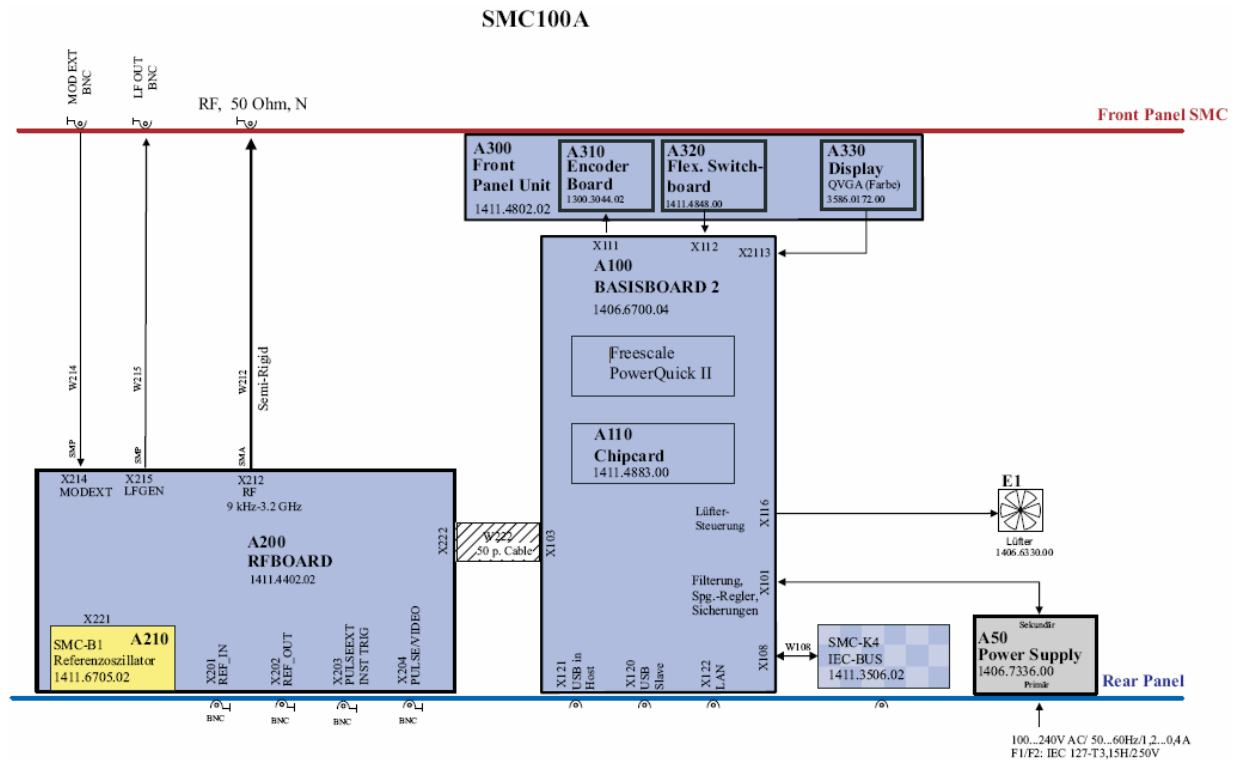

The R&S SMC100A consists of very few main modules and very few connections between these modules. The main units are:

- Power Supply
- Basis Board which includes all digital external Interfaces, the main CPU, the Fan control logic, the hardware drivers for the front panel and the Interface for the RF Board
- Front Unit consisting of the rotary knob with encoder, the flexible switch board and the QVGA Color Display
- RF Board including the whole measurement hardware
- R&S SMC-B1 Reference Oscillator which is plugged direct into the RF Board.

A detailed description of these modules is given in the next chapter.

RF Board

The RF BOARD contains the complete measuring hardware of the instrument. The RF and LF signals are generated and modulated on the module. The output level is controlled by a level control loop controlling the level before the step attenuator. The fully electronic step attenuator is temperature compensated to achieve very precise output levelling of the instrument. The RF Board is equipped with a reverse power protection to ensure the instrument not being damaged due to supplying reverse power to the RF output of the instrument. The module is controlled by the Basis Board via a serial bus and few additional control signals.

Implemented functions:

- Reference crystal oscillator and reference frequency switch
- Synthesizer
- LF generator
- Pulse generator and Pulse modulator control
- Modulation matrix and DDS with AM/FM/PhiM modulator
- AM modulator
- Harmonics filters
- Pulse modulator
- RF amplifiers
- Level control
- Step Attenuator
- Reverse power protection
- Diagnostics

Internal and external 10 MHz reference

The instrument's reference frequency is determined either by the built-in TCXO, the optionally built-in OCXO (option R&S SMC-B1), or by an external 10 MHz reference signal that is fed to the input X201 REFIN. The output X202 REFOUT provides a buffered 10 MHz signal, which has been derived from the active reference source.

TCXO 20 MHz crystal oscillator

In Reference internal mode without OCXO (Option R&S SMC-B1) the 20 MHz TCXO is the internal reference signal for the Synthesizer and LF generator. In this mode, the frequency of the TCXO can be adjusted by a DAC. When the 10 MHz OCXO (Option R&S SMC-B1) is plugged into the RF Board or Reference external mode is chosen the 20 MHz TCXO is synchronized to the 10 MHz reference signal with a PLL. In Reference internal mode without the OCXO the 10 MHz output signal for X202 REFOUT is derived from the internal 20 MHz TCXO by the means of a frequency divider. In Reference external mode or with OCXO fitted the 10 MHz reference signal is fed straightforward to the 10 MHz REFOUT connector X202.

RF Synthesizer/DDS

The multiplied 20 MHz signal of TCXO provides the system clock for the DDS. The RF signals from DC to 23.4375 MHz are generated directly by the DDS. In this mode all the modulation is done fully digital. The modulated signal is converted to the analog domain by a DAC. The analog RF signal is amplified low pass filtered and fed to the input of the step attenuator. For frequencies above 23.4375 MHz the DDS generates a reference signal for the frequency synthesizer providing the fine frequency resolution for the frequency synthesis. In the synthesizer a VCO is locked to the reference frequency from the DDS. The RF signal is then generated by the means of fixed frequency dividers set to the appropriate divider ratio.

Harmonics filters

The output signal of the frequency dividers is a square wave signal. To reach the guaranteed harmonic performance (see datasheet) the harmonics of the RF signal have to be suppressed. Due to the wide RF frequency range multiple filters are needed. The different filters are selected according to the RF output frequency and their cut off frequency. They are put into the RF signal path by the means of RF switches.

LF generator

A DDS generates the LF sine wave signal. This signal can be used as a source for internal modulation or as output signal at LFOUT BNC connector for frequencies up to 100 kHz. The output amplitude of the LF signal is set with a multiplying DAC in the range from 10 mV to 2.55 V.

Pulse generator and Pulse Modulator

The pulse generator is digitally implemented in an FPGA. The pulse generator has three different modes. The pulse generator can run free, can be triggered or gated externally using the PULSE EXT input. The input impedance at the PULSE EXT BNC connector is fixed to high-impedance. The pulse signal serves as a source for internal pulse modulation and can additionally be applied at the output PULSE VIDEO in a buffered way. Below 23.4375 MHz the pulse modulator is implemented digitally switching on and of the output signal of the DAC. Above 23.4375 MHz three CMOS FET switches are used as pulse modulator.

Modulation matrix and AM/FM/ ϕ M modulator

The external modulation signal from MODEXT can be AC- or DC-coupled. This signal is converted into the digital domain by the means of a 10 Bit ADC. The Frequency and Phase Modulations are implemented fully digital. For output frequencies below 23.4375 MHz the AM is implemented fully digital as well. For RF frequencies above 23.4375 MHz, the modulation signal is applied as reference signal to the level control loop. The AM modulation depth is set by a multiplying DAC. A switch matrix to select internal or external modulation signals is implemented in analog circuitry and additionally in the digital domain.

AM modulators

Below 23.4375 MHz in the DDS RF frequency range the AM is generated digitally. For RF frequencies above 23.4375 MHz a PIN modulator is used.

Automatic Level control

A RF detector at the output of the power amplifier is used to obtain information about the actual output power. This information signal is fed back to the Automatic Level Control (ALC) unit. The ALC sets the Level Control Voltage controlling the AM modulator to reach the desired output level.

Step Attenuator and reverse power protection

Due to the limited dynamic range of the ALC RF detector the regulated RF signal is attenuated with passive attenuators. The step attenuator is a settable attenuator with known attenuation. At the RF output of the RF Board a reverse power protection circuitry detects RF power fed into the RF Board from outside the instrument. To protect the R&S SMC100A against damage a relay disconnects the RF output, when excessive reverse power is detected. In standby or power off mode this relay is also in off state to protect the RF output of the instrument against damage.

Supply voltage control and filtering

The module supply voltages are filtered by means of passive filtering and additional active voltage regulators. Linear regulators with very good noise and distortion suppression characteristics have been implemented based on operational amplifier circuitry.

Power Supply Module

The power supply module provides all currents necessary for the operation of the signal generator. It can be switched on and off by means of the power switch on the rear panel. After switch-on, the instrument is either in standby or in operating mode, depending on a value stored in an internal EEPROM.

The power supply works over a wide input voltage range from 100 V to 240 V ($\pm 10\%$) and AC supply frequencies from 50 Hz to 60 Hz ($\pm 5\%$). The power factor correction meets EN 61000-3-2.

On the secondary side, the power supply generates three DC voltages (+5.0 V, +13.25 V, -13.25 V) and one standby voltage (+5 V), all $\pm 5\%$.

The control signal POWER_ON_N controlled by the front panel controller (depending on the operating key STBY on the front of the instrument frame) switches the power supply from standby mode to operating mode. In standby operation, it only supplies a 5 V standby to supply the front panel controller and the STBY LED on the front panel.

The secondary voltages are open-circuit-proof and short-circuit-proof with respect to ground and each other.

The power inlet module contains two fuses. Replace these fuses only with type and rating specified on the rear panel. If the replaced fuse blows again, change the module.

Further fuses are fitted on the Basis Board as a means of fire protection.

Basis Board

The Basis Board of the signal generator involves the following components and modules:

Fuses

Each supply voltage is fused with one or several fuses on the Basis Board.

Switching regulators

Switching regulators for 1.2 V, 1.8 V, 3.3 V, 7 V and 28 V supply voltages: These supply voltages are generated by means of switching regulators.

Controller

Central Controller of the R&S SMC100A including all memory devices and external interfaces.

FPGA (SMB_COM)

This FPGA performs data processing for the serial bus, which sends setting data to the modules. The SMB_COM is configured via an SPI-Interface of the processor. The Display Controller and timer functions are also implemented in the SMB_COM.

Keyboard Controller

The keyboard controller notifies the processor about keyboard and spin wheel events. The keyboard controller switches on or off the power supply module and memorizes the power on state of the instrument when the main power is cut. This state is reconstituted on powering the instrument again.

Diagnostic ADC

The diagnostic ADC is used for measuring the voltages in the unit. These voltages are used for internal adjustments and the ALC S&H mode of the R&S SMC100A. Additionally the failure diagnostic of the instrument is carried out by the use of ADC.

EEPROM

The following data is stored here: Header line data of the board and service information.

SIM Card

A SIM card is used for identification of the instrument (e.g. serial number).

Temperature sensor

A temperature sensor mounted on the Basis Board monitors the temperature. If a defined temperature above the guaranteed maximum operating temperature is exceeded, the power supply is switched off. So the R&S SMC100A secures itself against damage due to overheating.

Fan Controller

A Fan for cooling the RF modules is connected to the Basis Board and directly controlled according to the temperature of the Basis Board. This is done independent of the controller.

Troubleshooting

The purpose of these troubleshooting instructions is to help to trace down malfunctions to board level. The instrument can thus be made ready for use again by means of board replacement.

If error tracing doesn't show clear results, we recommend that you ship your instrument to our experts in the service centers (see address list) for module replacement and further error elimination. Some module replacements involve calibration procedures requiring calibrated equipment and appropriate software.

CAUTION



Danger of shock hazard

For module replacement, ensure that the instrument is switched off and disconnected from the power supply by removing the plug from the AC and DC power connector.

Read all safety instructions at the beginning of this manual carefully before module replacement!

NOTICE

Risk of damage to the boards

Be careful not to cause short circuits when measuring voltages at pins placed close together!

The following utilities are provided in the signal generator for easy diagnosis:

- Internal selftest
- Internal diagnosis test points
- Internal adjustments
- Info line with error messages and history of messages
- Internal keyboard test

Note: When problems occur, first check whether any connections (cables, plug-in connections of boards, etc) are damaged or wrongly connected.

Measuring Equipment and Accessories

Item	Type of equipment	Specifications recommended	Equipment recommended	R&S order No.
1	DC voltmeter		R&S URE	0350.5315.02
2	Spectrum analyzer	Frequency range 0 to 7 GHz	R&S FSP	1164.4391.07
3	Adapting cable	1 m long SMP-to-SMA connection	-	1129.8259.00
4	Oscilloscope	100 MHz	Hameg HM504-2	

Switch-On Problems

The yellow LED on the front panel, next to the ON/OFF Button is directly connected to the Standby Voltage of the power supply (via a resistor on the Basis Board) and is therefore a good indicator of the basic working of the power supply.

When the instrument is switched on, the following modules are involved:

- Power supply
- Basis Board
- Switching pad

To analyze switch-on and switch-off problems that occur with the R&S SMC100A, the interplay of the individual modules is summarized in the following.

Switch-on

When the ON/OFF button on the front panel is pressed, the voltage of the ON/OFF testpoint at X112 (switching pad connector) goes low. In this case the Basis Board pulls the signal on pin 13 of X101 (power supply connector see [Fig. 3-4](#)) low, which in turn switches on the power supply. In case of a prior emergency shutdown (pressing the ON/OFF Button for more than 5 seconds) it may take a few seconds until this mechanism works again.

Within four seconds after switch-on, the CPU takes over the control of pin 13 of the power supply connector. If the green LED on the front panel lights up for only a short time (approx. five seconds) and then the orange standby LED lights up again, this means that the CPU is not booting properly. The cause may be a defective or overheated power supply or Basis Board.

Switch-off

Besides pressing the power switch, the instrument can be switched off in three ways.

After briefly pressing the ON/OFF button on the front panel, the CPU performs a normal system shutdown and then powers off the power supply via pin 13 of the power supply connector.

Pressing and holding the button on the front panel for longer than five seconds leads to an emergency shutdown, which is controlled by special hardware on the Basis Board. In this case, no user data can be saved.

The instrument can also be switched off by means of the temperature monitoring circuit on the Basis Board. If the temperature sensor on the Basis Board detects an over temperature (e.g. in the event that a fan fails), the power supply is switched off via pin 13 of the power supply connector. It can only be switched on again, after cooling down.

• **Error: Instrument cannot be switched on.**

Action	Possible error causes and further steps
Check power-on switch on the rear. Check fuses on the rear. ↓	Power switch OFF: Switch on power supply.
Check yellow LED (standby). ↓	LED remains unlit: Measure standby voltage at pin1 X101 (see Fig. 3-1). Rated value: 4.75 V... 5.25 V No voltage: Check power cable from power supply. no/faulty voltage: change power supply Otherwise: Loose Flex Switchboard (in X112) or bad contacts

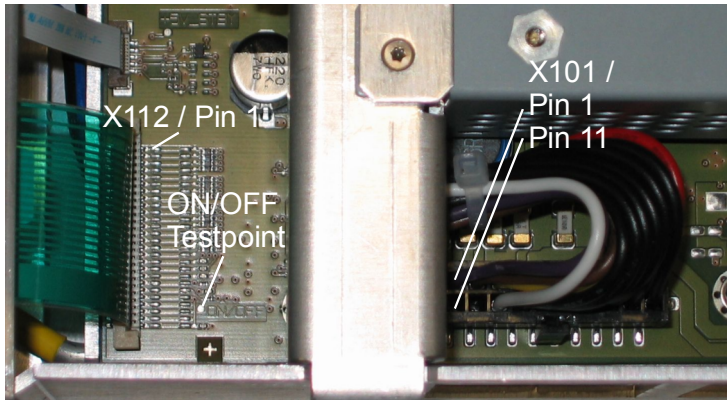

Fig. 3-1 ON/OFF Testpoint, X101 and X112 location on the Basis Board

• **Error: Signal generator starts up but display remains black**

Description of error	Possible error causes and further steps
CPU does not boot correctly	Check red LED on Basis Board (see Fig. 3-2). If LED does not turn red approx. 1 sec after power on, either the Basis Board FPGA does not configure correctly or the CPU does not boot: try to update the firmware, which includes the FPGA configuration data. If this does not help: Change Basis Board
Cables are loose	Check cabling between Basis Board and Display
TFT display defective	Replace Front panel with TFT display

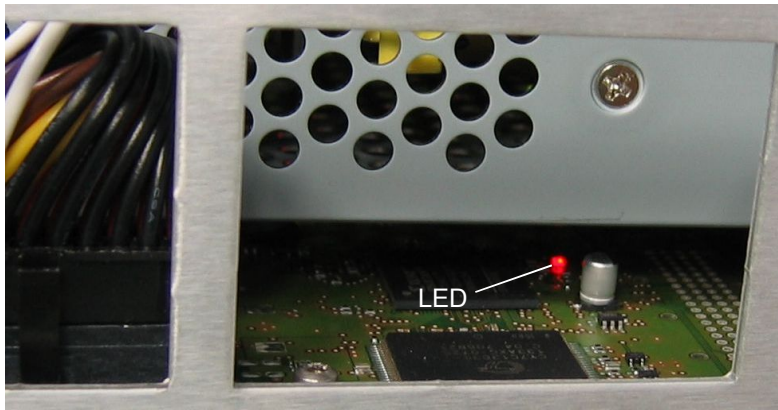

Fig. 3-2 Red LED location on the Basis Board

• **Error: Fan does not work**

Description of error	Possible error causes and further steps
Fan does not work	<p>Disconnect fan and check voltage on Basis Board X116 (fan connector) between pin 1 and 2 (see Fig. 3-3): Rated voltage: 8 V ... 13 V, depending on temperature.</p> <p>Correct voltage: Replace fan</p> <p>Faulty voltage: Check the power supply of the Basis Board (see page 3.21).</p>

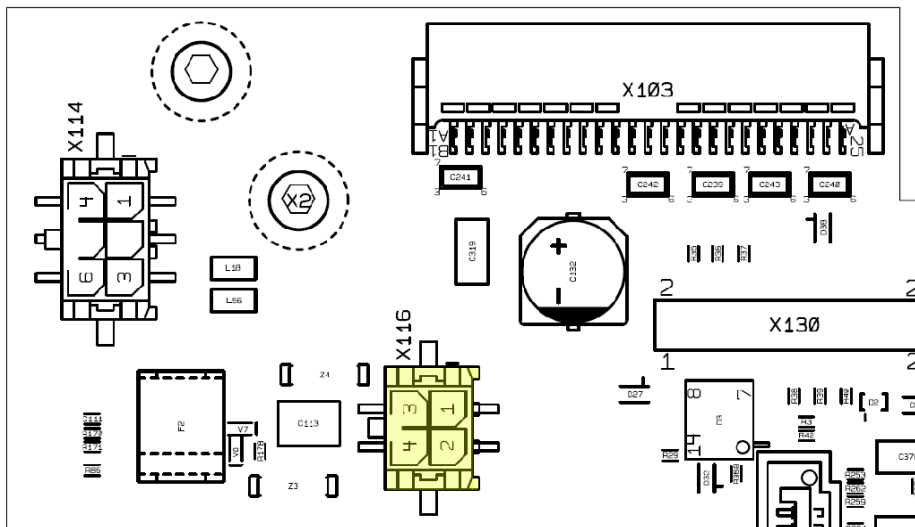



Fig. 3-3 X116 Fan Connector Pin Location

Problems with Booting

- **Error: Unit does not start the application**

After switch-on, the signal generator first runs the Boot Loader. The Boot Loader displays the R&S Logo. The Boot Loader loads the FPGAs on the Basis Board and on the RF Board. After successful initialization of the computer (approx. 10 seconds), the LINUX operating system starts up and displays the background picture. Subsequently, the application is loaded. During loading, several progress bars are shown on the display.

All software of the R&S SMC100A is stored in an on board flash memory. There are no serviceable hardware parts related to mass memory. The only possible service action is the reinstallation of firmware, which requires at least some basically working computer and firmware.

Normal action	Error, possible causes and corrective action
<p>Start signal generator</p>	 <p>R&S logo does not disappear</p> <p>Error: The operating system (LINUX) does not start.</p> <p>Try to reinstall the firmware with the help of the maintenance system. If this is not possible or does not solve the problem, replace the Basis Board.</p>

Keyboard and Rotary Knob Test

- This **utility** allows you to check for proper operation of all front panel control elements

Normal action	Error, possible causes and corrective action
Test called with SETUP - Check Front Panel...	
An image of the front panel appears with gray keys. When a key is pressed once or the knob is moved, the field changes to green. If the key is pressed more than once, the field changes to red.	<hr/> <p>Note: <i>Be careful with the rotary knob! Turn only slightly in the specified direction; otherwise the field will change to red.</i></p> <hr/>
When all operating elements including the rotary knob have been actuated once, all fields are green. If operating elements have been actuated twice, the fields are red.	If the color changes to red at the first actuation, a malfunction has occurred (bouncing). If the color of the corresponding field remains the same after actuation, the function is defective. In either case: Change the switching pad and/or rotary knob.
A message is output when all keys have been pressed: "All Front Panel Keys were accessed correctly"	<hr/> <p>Note: <i>No error message is output even if a number of keys are red. The user must decide whether a malfunction has occurred.</i></p> <hr/>

Troubleshooting with Internal Self Test

The internal selftest checks the instrument by measuring internal diagnostic points. **In case of an instrument fail this check should always be done first.**

Execute **SETUP** - **Selftest**. The selftest reports the modules failing the test:

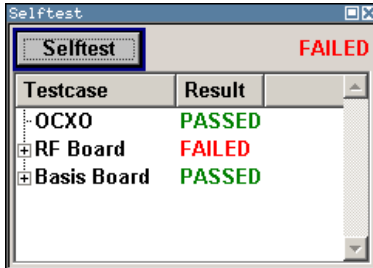

The screenshot shows a window titled 'Selftest' with a 'Selftest' tab and a 'FAILED' status indicator. Below the tab is a table with two columns: 'Testcase' and 'Result'.

Testcase	Result
OCXO	PASSED
RF Board	FAILED
Basis Board	PASSED

To see the details of the selftest select the board failing the selftest:

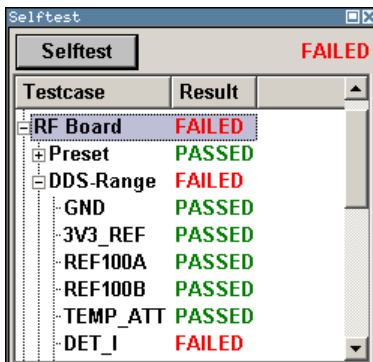

The screenshot shows the 'Selftest' window with the 'RF Board' row expanded. The 'RF Board' row is highlighted in red and shows a 'FAILED' result. Below it, several sub-testcases are listed with their results.

Testcase	Result
RF Board	FAILED
Preset	PASSED
DDS-Range	FAILED
GND	PASSED
3V3_REF	PASSED
REF100A	PASSED
REF100B	PASSED
TEMP_ATT	PASSED
DET_I	FAILED

If the Basis Board fails this test check the fuses and supply voltages from the power supply (see page 3.21). When the Basis Board fails this test the other modules cannot work correct. So only if the Basis Board passes the selftest, check the other modules failing the selftest.

Troubleshooting with Internal Test Points

The **Protection** menu provides access to the unlocking of protected service functions (authorized personnel of R&S Service Departments only). To deactivate the protection, the correct password has to be entered. After the instrument has been switched on, the protection levels 1 to 5 are automatically activated.

Protection Level 1 can be deactivated to expand the functionality of the internal adjustment, to change the host name and to access the test points. The password is 123456.



A diagnostic A/D converter on the Basis Board allows you to measure voltages at internal test points, which are located on all important modules of the instrument.

Diagnostic test points are located on following modules:

- Basis Board
- RFBOARD

The internal selftest checks all voltages at the points listed below, so if the selftest passes without a fail skip this manual test.

Normal action	Error, possible causes and corrective action
<p>Internal diagnosis switched on with: <input type="button" value="SETUP"/> - Test Points...</p> <p>Select the desired test point under Select Test Point.</p> <p>To operate, set State ON</p>	
<p>The measured voltage is displayed under Voltage.</p> <p>"99.9999V" means that the test point does not exist.</p> <p>The diagnostic system operates with multiplexers on each board to switch the desired test point to the common line named DIAG on the Basis Board. Each test point is switched to the line only for the time of a measurement and switched off after it. The A/D converter is located on the Basis Board.</p> <p>It is advisable to begin by checking the test points on the Basis Board, since the diagnostic converter is located on this module.</p>	<p>For troubleshooting refer to the following chapters.</p> <p>Compare the displayed values with the values specified in the next table.</p> <p>Major deviations from the named values indicate a defect: Change the affected module.</p> <p>If all test points are out of tolerance, maybe only one of the modules is defective and disturbs the diagnostic system. To determine which module is defective, remove all modules that include test points one after another, except the Basis Board. If values are still out of tolerance, replace the Basis Board.</p> <p>If the remaining test points are in tolerance after removing a module the module removed is defective. Replace this board.</p>

Module	Test Point	Min	Max	Function
Basis Board	DIAG_SMB_BAB_ADCGRD	-25 mV	25 mV	Reference Ground
	DIAG_SMB_BAB_P7V	6.4 V	7.6 V	Supply Voltages
	DIAG_SMB_BAB_P5V	4.6 V	5.4 V	
	DIAG_SMB_BAB_P3V3	3.1 V	3.5 V	
	DIAG_SMB_BAB_P12V	12.2 V	14.3 V	
	DIAG_SMB_BAB_P0V9	0.88 V	0.92 V	
	DIAG_SMB_BAB_P28V	25.8 V	30.2 V	
	DIAG_SMB_BAB_P2V5	2.3 V	2.7 V	
	DIAG_SMB_BAB_P1V2	1.1 V	1.3 V	
	DIAG_SMB_BAB_M12V	-14.3 V	-12.2 V	
	DIAG_SMB_BAB_TEMP	0	75°C	
	DIAG_SMB_BAB_VREF	3.15 V	3.45 V	
	RF Board	DIAG_SMC_RF_GND	-100 mV	100 mV
DIAG_SMC_RF_REF3V3REF		3.15 V	3.45 V	Supply Voltage
DIAG_SMC_RF_REF100A		1.5 V	4.0 V	
DIAG_SMC_RF_REF100B		500 mV	2.0 V	
DIAG_SMC_RF_TEMP_ATT		-5°C	75°C	Temperature
DIAG_SMC_RF_DET_I		-50 mV	2.0 V	
DIAG_SMC_RF_VDETTUNE		-50 mV	5.1 V	
DIAG_SMC_RF_VCO_PLL		-50 mV	2.0 V	
DIAG_SMC_RF_VDET		-50 mV	8.0 V	
DIAG_SMC_RF_LEVELREF		-9.0 V	50 mV	
DIAG_SMC_RF_LCON		-1.5 V	11.0 V	
DIAG_SMC_RF_MODEXT		-1.05 V	1.05 V	Extern Modulation Input
DIAG_SMC_RF_TCXOCTRL		-50 mV	3.45 V	
DIAG_SMC_RF_PDDIVREF		-50 mV	3.45 V	
DIAG_SMC_RF_TCOMP		-50 mV	2.2 V	
DIAG_SMC_RF_2LOOPF		-3.0 V	28.0 V	

Troubleshooting with Internal Adjustments

Various internal adjustments are necessary for correct operation of the instrument. The failure of a certain adjustment can shorten troubleshooting considerably. The affected module is the RF Board module.

Note: Failed internal adjustments can also be queried on the info page -> History.

Normal action	Error, possible causes and corrective action
<p>Internal adjustments call: <input type="button" value="SETUP"/> - Internal Adjustments... - Adjust All Internal adjustment of the RF Board is executed.</p>	<p>Abort during adjustment:</p> <p>The adjustments are all carried out exclusively on the RF Board, only the Diagnostic A/D converter on the Basis Board is needed. Check the Test Points on the Basis Board (see page 3.14).</p> <p>If the Test Points on the Basis Board are in tolerance most probably the RF Board is defective. Check the RF Board being supplied correct (see page 3.23). If not in tolerance check the Basis Board (see page 3.21).</p>

Instrument Faults

The following table lists R&S SMC100A Faults. For every fault additional test are described to determine the defective module.

Fault	Test	Action if test fails
RF Output Level is wrong	R&S SMC100A settings: Instrument Preset Reference internal RF on Level = 8 dBm Measure the Output Level with a power meter across the frequency range. The difference between set and measured level has to be lower than guaranteed in the datasheet.	Check the mating torque of the SMA-connector at cable W 212 being 80 N cm to 110 N cm. Most probably the RF Board is defective. Check the RF Board being supplied correct (see page 3.23).
RF Output Frequency is wrong	R&S SMC100A settings: Instrument Preset Setup ➔ Adjustment ➔ "Adjust all" Setup ➔ Reference external RF on Level: 0 dBm Supply an external 10 MHz reference signal meeting the level and frequency specification given in the datasheet. Measure output frequency with a spectrum analyzer or a frequency counter synchronized to the same reference. The frequency error has to be < 0.1 Hz.	Most probably the RF Board is defective. Check the RF Board being supplied correct (see page 3.23).
	R&S SMC100A setting: Setup ➔ Reference internal Measure the 10 MHz reference output signal with spectrum analyzer or frequency counter and power meter. Output frequency and level have to meet the specifications given in the data sheet.	Without Reference Oscillator R&S SMC-B1 being equipped most probably the RF Board is defective. Check the RF Board being supplied correct (see page 3.23). If the R&S SMC100A is equipped with Reference Oscillator R&S SMC-B1 remove the unit see page 3.57) and perform this test again. If it works most probably the Reference Oscillator R&S SMC-B1 is defective Check the Reference Oscillator being supplied correct (see page 3.28).

Fault	Test	Action if test fails
<p>Poor Harmonic Distortion</p>	<p>R&S SMC100A settings: Instrument Preset Reference internal RF on ATT-Mode Auto Level = Maximum guaranteed level for harmonic distortion (see datasheet) Measure the level of the fundamental frequency with a spectrum analyzer. The level of every harmonic has to be at least 30 dB lower than the level at the fundamental frequency. Repeat this test over the frequency range of the instrument. Comment: In ATT-Mode fixed harmonic distortion is not guaranteed above Levels displayed under "Level" menu ➔ "Attenuator Settings" ➔ "Fixed Range in".</p>	<p>Most probably the RF Board is defective. Check the RF Board being supplied correct (see page 3.23).</p>
<p>Overvoltage protection does not trigger</p>	<p>Switch on RF -> apply a RF power of >1 W to RF N connector -> The overvoltage protection must trigger.</p>	<p>If RF output is not switched of the RF Board is defective.</p>
<p>Slow Settling times</p>	<p>Settling times are defined for GPIB remote control only. The settling time is the time-delay after asserting EOI until level and frequency are within the given tolerance from their final values. Be careful not to measure with an instrument drifting on its own due to applying the RF from the R&S SMC100A.</p>	<p>Most probably the RF Board is defective. Check the RF Board being supplied correct (see page 3.23).</p>
<p>10 MHz Reference Input faulty</p>	<p>Check the 10 MHz reference signal fed into the R&S SMC100A with a spectrum analyzer or frequency counter and power meter. If level and frequency of this signal is matching the specification in the datasheet set the R&S SMC100A to: Instrument Preset Reference external RF on Frequency = 1 GHz Level = 0 dBm Check for error Messages. No "External Reference Errors" are allowed to occur. Measure output frequency with a spectrum analyzer or a frequency counter synchronized to the same reference. The frequency error has to be < 0.1 Hz.</p>	<p>Most probably the RF Board is defective. Check the RF Board being supplied correct (see page 3.23).</p>

Fault	Test	Action if test fails
<p>10 MHz Reference Output faulty</p>	<p>R&S SMC100A setting: Setup ➔ Reference internal</p> <p>Measure 10 MHz reference output signal with spectrum analyzer or frequency counter and power meter. Output frequency and level have to meet the specifications given in the data sheet.</p>	<p><i>R&S SMC100A without Reference Oscillator R&S SMC-B1:</i></p> <p>Most probably the RF Board is defective. Check the RF Board being supplied correct (see page 3.23).</p> <p><i>R&S SMC100A with Reference Oscillator R&S SMC-B1:</i></p> <p>Remove the Reference Oscillator R&S SMC-B1 (see page 3.57) and perform this test again. If still failing most probably the RF Board is defective. Check the RF Board being supplied correct (see page 3.23).</p> <p>If the 10 MHz reference signal is in tolerance most probably the Reference Oscillator R&S SMC-B1 is defective. Check this module being supplied correct (see page 3.28).</p>
<p>LFGGen Output Faulty</p>	<p>R&S SMC100A settings: LFGGen Stat off</p> <p>Measure the input resistance of the LF signal output with a multimeter. The input resistance should be $10 \Omega \pm 10 \Omega$.</p> <p>R&S SMC100A settings: Setup ➔ Reference internal LFGGen Stat on LFGGen Level 1 V LFGGen Frequency 100 kHz</p> <p>Attention: LF specification applies to loads greater or equal 50Ω only!</p> <p>Check the level at the "LF"-BNC Connector with an oscilloscope or voltage meter. Check the frequency and harmonic distortion with an oscilloscope with FFT functionality or with a spectrum analyzer.</p>	<p>Check the connection of cable W215 to the RF Board (see page 3.52).</p> <p>If it is connected correct most probably the RF Board is defective. Check the RF Board being supplied correct (see page 3.23).</p> <p>Most probably the RF Board is defective. Check the RF Board being supplied correct (see page 3.23).</p>
<p>MOD Ext Input Faulty</p>	<p>Measure the input resistance of the Mod Ext BNC connector signal with a multimeter. The input resistance should be $221 \text{ k}\Omega \pm 20 \%$</p>	<p>Check the connection of cable W214 to the RF Board (see page 3.52).</p> <p>If connected correct most probably the RF Board is defective. Check the RF Board being supplied correct (see page 3.23).</p>

Fault	Test	Action if test fails
<p>Amplitude Modulation Faulty</p>	<p>The AM is specified only up to the Peak Envelope Power (PEP) noted in the datasheet. The PEP value of an AM signal with depth m at setting level P is</p> $P_{PEP} = \text{Level} + 20 \log_{10}(1 + m/100)$ <p>So at m = 100 % the PEP is 6.02 dB higher than the setting level shown in the display.</p> <p>The AM performance has to match the values given in the datasheet. Measure with a true demodulating receiver, i.e. a R&S FSMR or R&S FSL/ FSP/ FSU/ FSQ spectrum analyzer equipped with option R&S K7</p>	<p>Most probably the RF Board is defective. Check the RF Board being supplied correct (see page 3.23).</p>
<p>Frequency/ Phase Modulation Faulty</p>	<p>FM and PhiM Modulation are generated in the DDS synthesizer reference signal on the RF Board. Run Internal Adjustments to ensure the VCOs generating the RF signal working in their optimum.</p> <p>The FM performance has to match the values given in the datasheet. Measure with a true demodulating receiver, i.e. a R&S FSMR or R&S FSL/ FSP/ FSU/ FSQ spectrum analyzer equipped with option R&S-K7</p>	<p>Most probably the RF Board is defective. Check the RF Board being supplied correct (see page 3.23).</p>
<p>Pulse Generator/ Pulse Modulator Faulty</p>	<p>The pulse generator is implemented fully digital in the RF Board FPGA. The pulse signals are fed exclusive on the RF Board to the pulse modulator switch. All external pulse-BNC connectors are fitted on the RF Board as well.</p>	<p>Most probably the RF Board is defective. Check the RF Board being supplied correct (see page 3.23).</p>
<p>Faulty Remote interface IEEE488, USB or LAN</p>	<p>All remote interfaces including the interface connectors are fitted directly on the Basis Board.</p>	<p>Most probably the Basis Board is defective. Check the Basis Board being supplied correct (see page 3.21).</p>

Troubleshooting – Basis Board Module

Supply Voltages

Before Troubleshooting on the Basis Board switch the R&S SMC100A on and measure the supply voltages on its power supply connector (X101, see Fig. 3-4) and compare them to the values specified in the table below. Pin 13 is the Power On-Signal for the power supply. As long as the voltage at this pin is +5 V the power supply is switched off. The power supply is turned on by assigning 0 V to this pin. If one or more voltages are not of the required level, the power supply is defective.

Pin at X101	Test Point	Fuse	R&S SMC in stand by mode	R&S SMC switched On
5...10	+5V (1)	F4	0 V	+4.7 V ... +5.3 V
5...10	+5V (2)	F7	0 V	+4.7 V ... +5.3 V
3, 4	+13V2 (1)	F3	0 V	+12.4 V ... +14.2 V
3, 4	+13V2 (2)	F5	0 V	+12.4 V ... +14.2 V
2	-13V2	F6	0 V	-14.2 V ... -12.4 V
1	+5V_STBY	F9	+4.7 V ... +5.3 V	+4.7 V ... +5.3 V
13			> +3 V	< 0.8 V
14...20			GND	GND
	+28V		0 V	+25.8V ... 30.2V
	+7V		0 V	+6.4V ... +7.6V
	+3V3		0 V	+3.1V ... +3.5V
	+3V0		0 V	+2.85V ... +3.15V
	+2V5		0 V	+2.3V ... +2.7V
	+1V8		0 V	+1.7V ... +1.9V
	+1V2		0 V	+1.15V ... +1.25V

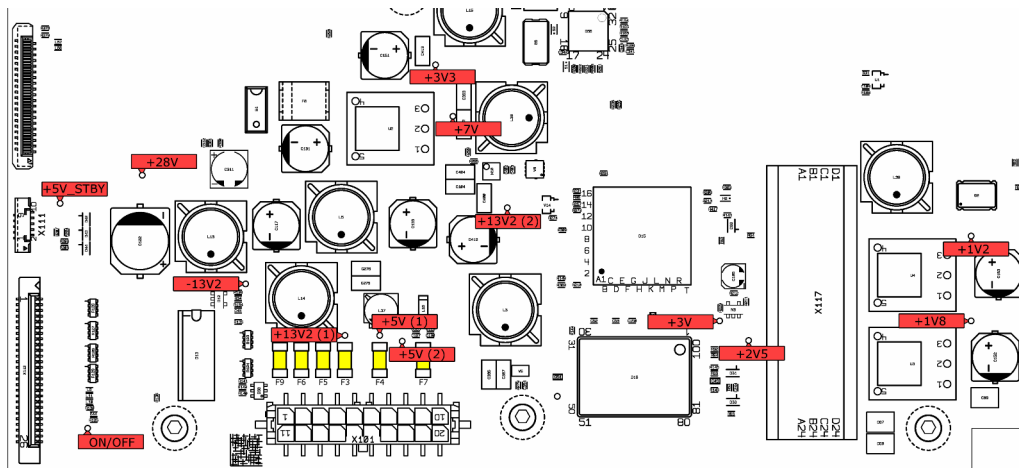

Fig. 3-4 Power Supply Test Points of the Basis Board

Fuses

Switch on the R&S SMC100A and measure the voltage drop across the fuses F3 – F7 (yellow marked see [Fig. 3-4](#)) with a multimeter. The voltage across every fuse should be in the range -100 mV ... +100 mV. The fuses might be blown due to a defective module other than the Basis Board. If one of the fuses is blown replace the fuse with the correct type given below. Remove connection W222 to the RF Board and the flex-strip cable of the display (A330) to the Basis Board. Switch on the R&S SMC100A and check the voltage drop across the fuses after two minutes again. If one of the fuses is blown again the Basis Board is defective. If the fuses are OK switch of R&S SMC100A again and then connect the display and switch on the R&S SMC100A again. If one of the fuses is blown after two minutes and the display is not working the display is defective. If the RF Board is equipped with the Reference Oscillator R&S SMC-B1 remove this unit first (see page 3.57). Now repeat the fuse test by first adding the connection to the RF Board and then adding the Reference Oscillator R&S SMC-B1. The module causing the blown fuse is defective.

Fuse	Type	R&S Part Number	Manufacturer Part Number
F3	T5A	1090.4442.00	Littlefuse R452.005 NRL (MRL)
F4	FF10A	6104.9199.00	Littlefuse R452.010 NRL (MRL)
F5	T5A	1090.4442.00	Littlefuse R452.005 NRL (MRL)
F6	T5A	1090.4442.00	Littlefuse R452.005 NRL (MRL)
F7	FF10A	6104.9199.00	Littlefuse R452.010 NRL (MRL)

Troubleshooting – RF Board module

The tests listed below ensure that an assumed error on the RF Board module is not caused by a defective or incorrectly connected cable, incorrect adjustment or another module.

A comprehensive test of the module is to run the internal selftest and the internal adjustments. See chapters "[Troubleshooting with Internal Self Test](#)" (see page 3.13) and "[Troubleshooting with Internal Adjustments](#)" (see page 3.16).

Supply Voltages

The supply voltages of the RF Board are inspected via the test points located on the bottom side of the RF Board nearby the ribbon cable connection (W222) to the Basis Board. Switch on the R&S SMC100A and measure the supply voltages of the RF Board at the test points shown in [Fig. 3-5](#). The measured voltages have to meet the values given in the table below. If one or more voltages are not of the required level, check the Basis Board (see page 3.21).

PCB label	Test Point	R&S SMC switched On
	Shielding enclosure	GND
Q22	+12V	+12 V ... +14 V
Q23	+7V	+6.5 V ... +7.5 V
Q24	-12V	-14 V ... -12 V
Q25	+28V	+26 V ... +30 V
Q26	+3V3	+3.1 V ... +3.5 V

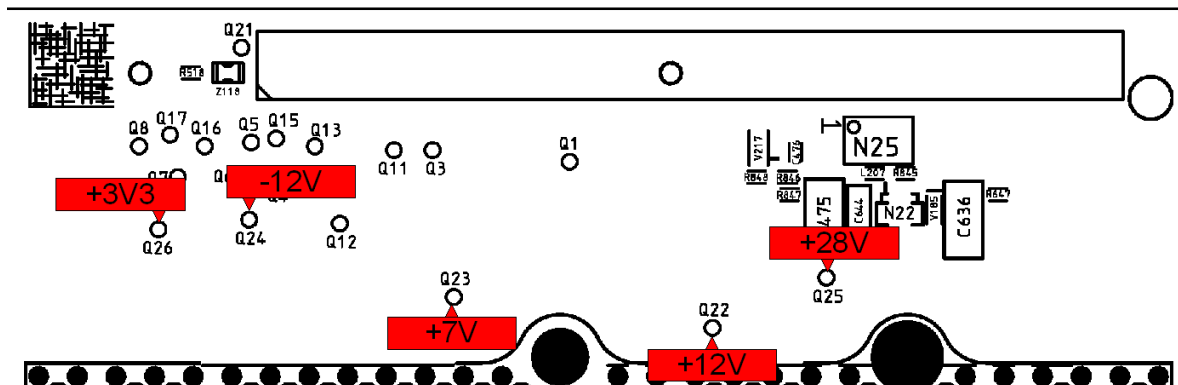

Fig. 3-5 Power Supply Test Points of the RF Board

Control Signals

The control signals of the RF Board can be measured at test points on the bottom side of the RF Board nearby the ribbon cable connection (W222) to the Basis Board. (see Fig. 3-6). Signals going to the RF Board are colored red and signals coming from the RF Board are colored blue.

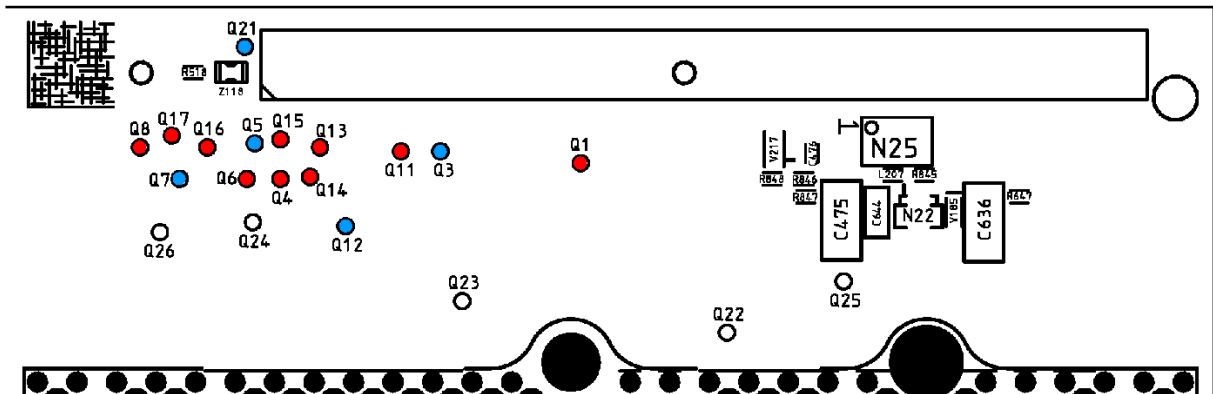

Fig. 3-6 Signal Test Points of the RF Board.

Perform the following settings at the R&S SMC100A:

- Preset
- RF on
- **SETUP** - **Protection...** (deactivate protection level 1, see 3.14) - **Test Point...** ⇒ **DIAG_SMC_RF_LCON**

Use the test points in the table below and control the signals with an Oscilloscope.

Oscilloscope settings:

- Voltage: 1V / Div
- Timespan: 1 μ s/ Div
- Trigger: Normal

Measure these signals

Test point	Function	Signal at normal operation	Defective
Q4, Q6, Q14, Q15	Logic Control Signals	Check the serial number of the RF Board displayed in the GUI: SETUP - Hardware-Config... – RF Board - More... If the number is correct these signals are OK. If not measure these Test-Points with an Oscilloscope: They should toggle between LOW and HIGH (LVC 3.3V)	Basis Board
Q5	Logic Control Signal		RF Board
Q11, Q13	Reset	HIGH (LVC 3.3V)	Basis Board
Q12	Interrupt Signal	normal Operation: HIGH (LVC 3.3V) Switch R&S SMC100A to Reference extern without applying 10 MHz Reference signal: LOW (LVC 3.3V)	RF Board
Q1	Blank Signal	normal Operation: LOW (LVC 3.3V) during Frequency switching: HIGH (LVC 3.3V)	Basis Board
Q3	Diagnosis Voltage	Voltage toggles on every update of the diagnosis	RF Board
Q8, Q16, Q17	Logic Control Signals	Check the serial number of the MOD-FPGA displayed in the GUI: SETUP - Hardware-Config... – MOD-FPGA – More... If the number is not 0.0 these signals are OK. If not measure these Test-Points with an Oscilloscope: They toggle between LOW and HIGH (LVC 3.3V) during the first seconds after switching on the instrument	Basis Board
Q7	Logic Control Signal		RF Board
Q21	Interrupt Instrument Trigger	no signal at PULSE EXT / INST TRIG X203: HIGH (LVC 3.3V) trigger signal at PULSE EXT / INST TRIG X203: inverted trigger signal (LVC 3.3V)	RF Board

If one of these Signals is not as described change the connector cable and test again. If the signals still not match their description change the defective board according to the table.

Internal Input and Output Signals

Connector, system	Signal name	Setting on signal generator	Frequency	Level	Signal flow
X212, SMA	RF	RF ON	9 kHz to 3.2 GHz	-120 dBm to +19 dBm	to N RF connector at front
X214, SMP	MOD EXT	AM/FM/PM Source Ext	0.0 to 100 kHz	-1 V to +1 V	from BNC MOD EXT at front
X215, SMP	LFGEN	LF output on	0.1 Hz to 100 kHz	0 V to 2.55 V	to BNC LF at front

Error Messages Concerning the RF Board Module

Error message	Error correction
"ALC unlocked"	<ul style="list-style-type: none"> ➤ Automatic Level Control ALC exceeds upper bound. ➤ Set attenuator mode "Auto".
"Synthesis main-loop PLL unlocked"	<ul style="list-style-type: none"> ➤ Execute Internal Adjustment "Adjust Synthesis". ➤ If the error message does not disappear change the module.
"Synthesis adjustment failed"	<ul style="list-style-type: none"> ➤ Execute Internal Adjustment "Adjust Synthesis". ➤ If error messages does not disappear, check the diagnosis (see Troubleshooting with Internal Test Points). If the diagnosis measurements work change the RF Board.
"Synthesis adjustment data invalid"	<ul style="list-style-type: none"> ➤ Execute Internal Adjustment "Adjust Synthesis". ➤ If error messages does not disappear, check the diagnosis (see Troubleshooting with Internal Test Points). If the diagnosis measurements work change the RF Board.

Warnings Concerning the RF Board Module

Warnings	Warning correction
"External reference oscillator out of range or disconnected"	<ul style="list-style-type: none"> ➤ Check the external reference input signal. ➤ If the input signal is correct and the error message is still displayed, change the module.
"Output protection tripped"	<ul style="list-style-type: none"> ➤ Excessive reverse power at the RF port tripped the output protection. ➤ Remove the overload condition and press the "RF ON/OFF" button to enter normal operation.
"Pep value greater than defined limit"	<ul style="list-style-type: none"> ➤ The peak envelope power (PEP) is higher than the set upper limit. ➤ Reduce the output level.
"Pep value less than defined lower bound (fix range)"	<ul style="list-style-type: none"> ➤ The peak envelope power (PEP) is lower than the permissible lower limit in the "fix range" mode of the attenuator. ➤ Increase the output level, set the attenuator mode to "Auto", or reset the "fix range" by briefly switching the attenuator mode to "Auto" and then switching back to "Fixed".
"Pep value greater than defined upper bound (fix range)"	<ul style="list-style-type: none"> ➤ The peak envelope power (PEP) is higher than the permissible upper limit in the "fix range" mode of the attenuator. ➤ Reduce the output level, set the attenuator mode to "Auto", or reset the "fix range" by briefly switching the attenuator mode to "Auto" and then switching back to "Fixed".
"Settings conflict, pep value vs. AM depth"	<ul style="list-style-type: none"> ➤ The peak envelope power (PEP) is higher than the permissible upper limit because of the set AM modulation depth. ➤ Reduce the output level or increase the level limit (e.g. by switching the attenuator mode to "Auto" if "Normal" or "Fixed" mode was set). Reducing the AM modulation depth will also eliminate the warning.
"Settings conflict, pep value greater than allowed level vs. frequency"	<ul style="list-style-type: none"> ➤ The full output level range cannot be utilized at low frequencies below 500 kHz because internal components may be overloaded. Reduce the output level to eliminate the warning.
"Settings-conflict: frequency vs. deviation vs. modulation-mode"	<ul style="list-style-type: none"> ➤ The deviation setting in frequency or phase modulation is incorrect. ➤ Check deviation setting of frequency or phase modulation.
"Settings-conflict: PulseGen"	<ul style="list-style-type: none"> ➤ Settings for the internal pulse generator are incorrect. Check timing settings of the pulse generator

Frequency Error

Error	Error correction
<p>Internal reference frequency: Frequency error greater than limit given in datasheet</p>	<p>➤ The frequency accuracy of the synthesizer is determined (set to internal reference, without option R&S SMC-B1 OCXO) by a highly stable 20 MHz quartz oscillator that is set to a calibrated frequency standard at the R&S factory. This oscillator is subject to ageing and can be recalibrated (see chapter 2 "Adjustment of internal Reference Frequency").</p> <hr/> <p>Note: <i>The internal reference can be impaired under the menu Setup - Reference Oscillator - Adjustment. This setting does not affect the factory adjustment and can be reset at any time by means of deactivation. If the tuning range is insufficient to reach the frequency error given in the datasheet the TCXO is defective. Replace the RF Board.</i></p>

Troubleshooting – Reference Oscillator option R&S SMC-B1

If a frequency error is observed which is greater than specified in the data sheet try to adjust the center frequency of the reference oscillator (see chapter 2 “Adjustment of internal Reference Frequency”). If it is not possible to meet the specifications by adjusting the center frequency the module is defective and should be replaced.

Input and Output Signals

The Reference Oscillator has only one Futurbus connector (X1). The Reference Oscillator is plugged into the RF Board (X221 see Fig. 3-7). All signals and the supply voltage are fed to the module through this connector. Check the voltages for the OCXO being according to the following table. To test the serial bus signals watch the signal lines while toggling between internal and external reference with an Oscilloscope. Voltage Levels between LOW and HIGH (LVC 3.3V).

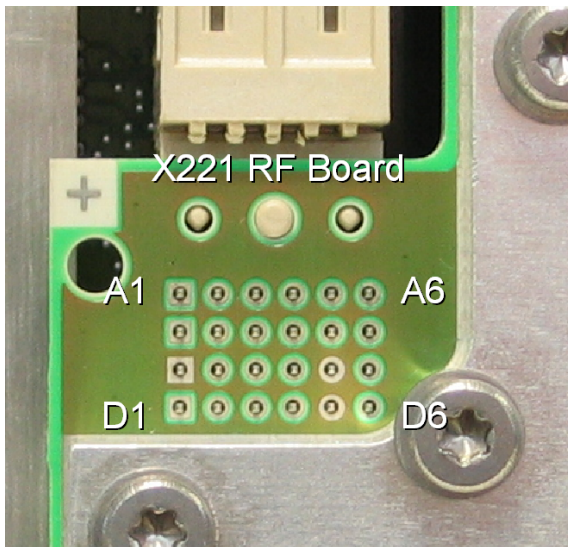

Fig. 3-7 Pin location X221 on RF Board

Pin of X221 RF Board	Voltage/Signal	Pin of X221 RF Board	Voltage/Signal	Pin of X221 RF Board	Voltage/Signal	Pin of X221 RF Board	Voltage/Signal
A1	Clock-signal serial bus	B1	NC	C1	GND	D1	+4.5 V - +5.5 V
A2	Data-signal to option serial bus	B2	0 V when Oven Cold	C2	NC	D2	0 V when option fitted
A3	Chip Select signal serial bus	B3	Data-signal from option serial bus	C3	+5.0 V when option on	D3	10 MHz LVDS signal
A4	NC	B4	NC	C4	NC	D4	
A5	NC	B5	NC	C5	GND	D5	GND
A6	+4.5 V - +5.5 V	B6	+4.5 V - +5.5 V	C6	+10.5 V – +12.5 V	D6	NC

Error Messages Concerning the Reference Oscillator Module

Error message	Error correction
➤ "OCXO 10 MHz oven cold"	➤ If this message does not disappear after 10 minutes, OCXO is defective, change the module.
➤ "Synchronization error on internal reference"	➤ Switch the R&S SMC100A to external Reference and supply a 10 MHz 10 dBm signal to the Reference Input of the RF BOARD. If the error disappears and the R&S SMC100A is working correct the OCXO is defective, change the module.
➤ "OCXO: cannot read EEPROM data" ➤ "OCXO: cannot store adjustment data"	➤ This indicates problems concerning the data transfer from and to the EEPROM of the module. If changing the module does not help, change the RF Board module.

Frequency Error, Reference Oscillator Adjustment

Error	Error correction
Internal reference frequency: Frequency error greater than limit given in datasheet	<p>➤ The frequency accuracy of the synthesizer is determined (set to internal reference) by a highly stable oven controlled 10 MHz quartz oscillator that is set to a calibrated frequency standard at the R&S factory. This oscillator is subject to ageing and can be recalibrated (see chapter 2 "Adjustment of internal Reference Frequency").</p> <hr/> <p>Note: <i>The internal reference can be tuned by up to approx. $\pm 10^{-6}$ under the menu Setup - Reference Oscillator - Adjustment. This setting does not affect the factory adjustment and can be reset at any time by means of deactivation.</i></p> <hr/>

Module Replacement

This section describes in detail the replacement of modules. Chapter 5 provides information on how to order spare parts; it contains the list of mechanical parts with order numbers and the illustrations for module replacement.

Required tools

- Star screwdriver TX 20
- Star screwdriver TX 8
- Star screwdriver TX 6

- Side cutter
- Flat pliers
- Forceps
- Tubular box wrench or a combinations wrench 16mm
- Torque wrench 8mm

Notice

Urgent

Please screw all the HF – conductions with the Torque wrench (60 Ncm) and NOT with an ordinary open-end wrench.

Please wear gloves, when you touch the electronic devices.

Overview of the Modules

Table 3-1 Overview - module replacement

Module	Designation	Order No.	See page
Power Supply (AC 90 V to 264 V)	A50	1406.7320.00	3.46
Basis Board 2	A100	1406.6700.04	3.48
RF Board	A200	1411.4402.02	3.52
Front unit R&S SMC100A	A300	1411.4802.02	3.35
Encoder Board	A310	1300.3044.02	3.39
TFT 3.5 QVGA DRGB LED 180MM	A330	3586.0172.00	3.39
Fan Unit	E1	1406.6330.00	3.55

Note: *The words "left" and "right" in the manual always refer to the front view of the instrument.*

After replacing an assembly

After you have replaced one of the assemblies, certain adjustments, functional checks or performance tests have to be carried out. Please refer to chapter 2 “Procedures after module replacement”.

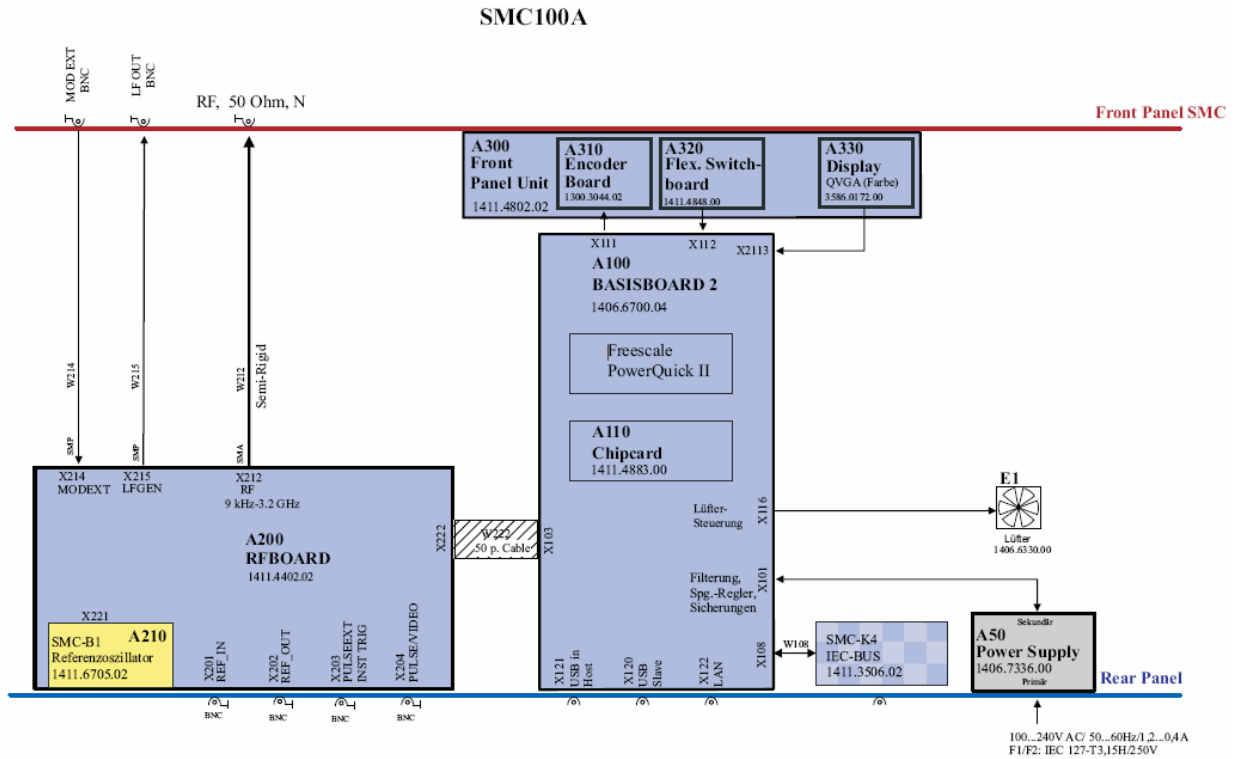

Safety Instruction

CAUTION Danger of injury



For module replacement, ensure that the instrument is switched off and disconnected from the power supply by removing the plug from the AC and DC power connector. Read all safety instructions at the beginning of this manual carefully before module replacement!
Only Rohde & Schwarz Service personnel and trained personnel may perform a module replacement.

When removing the rear feet, the unit can slip out of the cabinet.

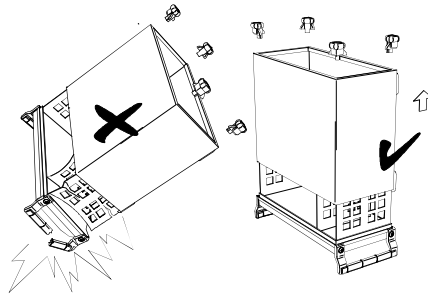

- Put the unit into the front handles, before removing the rear feet and taking off the cabinet. Thus the risk of personal injuries and damages to the unit is avoided.
- When mounting the cabinet take care not to pen in the fingers. Also pay attention not to damage or pull off cables. Screw the rear feet back on immediately after mounting the cabinet. Do not move the unit with the rear feet missing

CAUTION Risk of damage to the electronic components



To avoid damage of electronic components the operational site must be protected against electrostatic discharge

The following two methods of ESD protection may be used together or separately:

- Wrist strap with cord to ground connection.
- Conductive floor mat and heel strap combination.

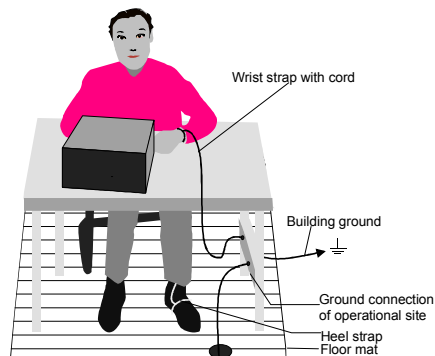

Dismounting the tube

- Put the instrument on the protective front corners.
- Unscrew the four screws of the 2 protective rear corners (rear right (550) and rear left (540)) on both sides and take them off.
- Pull off the tube R&S SMC100A (510).

When mounting the tube, take care not to damage or pull off cables!

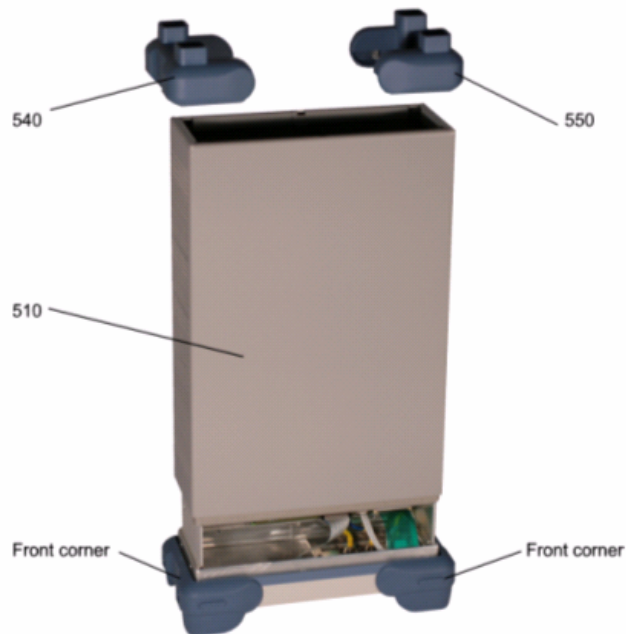

Mounting the tube

- Put the instrument on the protective front corners.
- Pull on the tube R&S SMC100A (510).
- Put the two protective rear corners (rear right (550) and rear left (540)) on the R&S SMC100A and screw it with the four screws.

When mounting the case, take care not to damage or pull off cables!

Replacing Fuse

NOTICE Risk of damage to the instrument

Ensure that the power supply cord is disconnected.

If you are not using the supplied spares, be sure to use fuses of the same type and rating.

- Switch off the instrument.
- Disconnect the power supply cord.
- To replace a fuse, unscrew the fuse holder at the rear panel of the instrument.

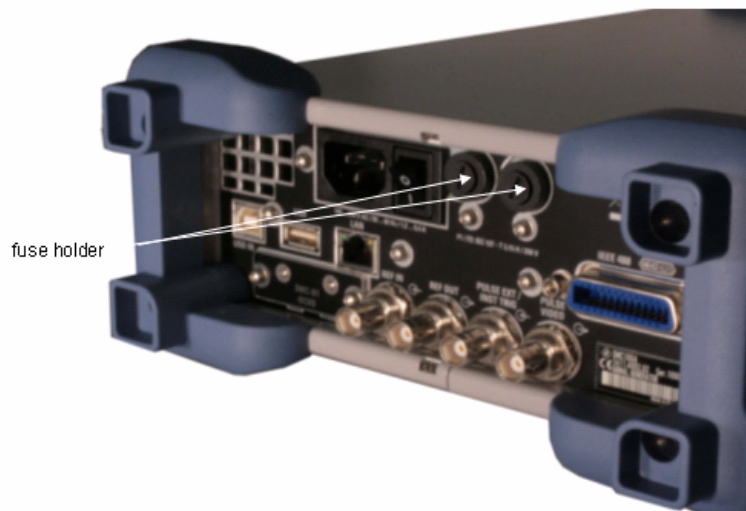

- Pull the fuse of the fuse holder.

Installing Fuse

- Push in the fuse in the fuse holder (Fuse 5 x 20 250V, 3,15A)
- Screw the fuse holder at the rear panel of the instrument.

Replacing the Front Unit (A300)

(See drawings Front Unit 1411.4802.01, Front Connector Plate 1411.4748.00 and R&S SMC100A 1411.4002.01).

NOTICE The new front unit 1411.4802.02 can be used on Basis Board 1406.6700.04 with change index starting from 4.00.

Removing the Front Unit A300 (1411.4802.02)

- Switch off the instrument and pull the mains plug.
- Dismounting the tube (see page 3.33).
- Disconnect the 4 screws, remove the protective corner front left and right (520) and (530) and the front cover R&S SMC100A (500).



- Disconnect the four screws (401), two on the top side and two on the bottom side of the front unit A300 (400).



- Pull off the flex. switch board cable (403) from X112, the flex-strip cable W310 (413) from X111 and the flex-strip cable of the display (408) from X2113 from the Basis Board 2 A100 (150).

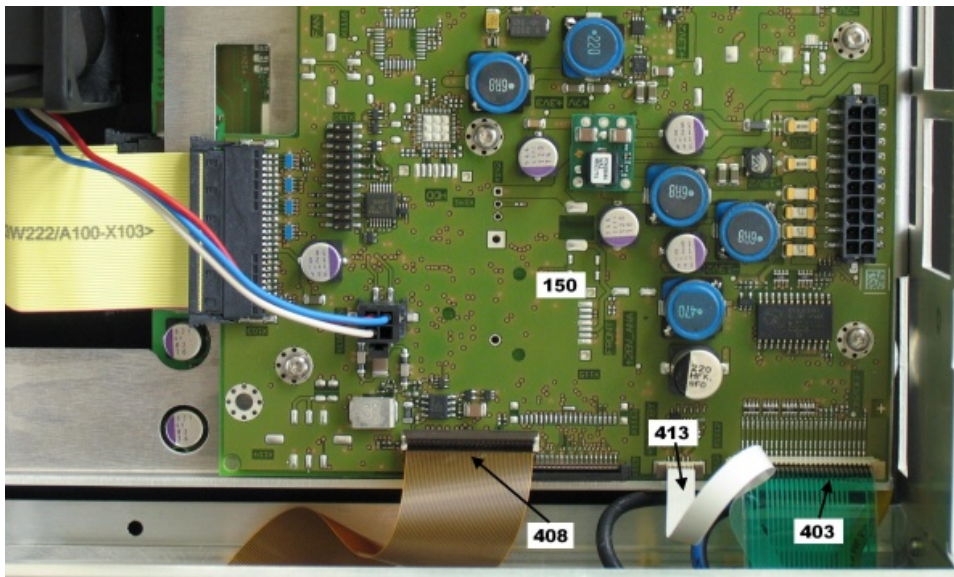

- Slice up the cable tie (208) and disconnect the cables W214 Mod Ext – RF Board (650), the W215 LF-RF Board (660) and W212 (630).

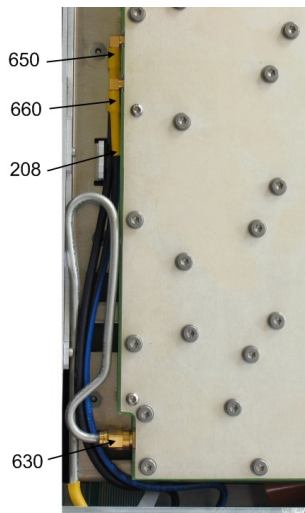

- Remove the front unit A300 (400) forwards.

Install the Front Unit A300 (1411.4802.02)

- Move the Front Unit A300 (400) backwards.
- Connect the cables W214 Mod Ext – RF Board (650), the W215 LF- RF Board (660) and W212 (630) and fix them with the cable tie (208).

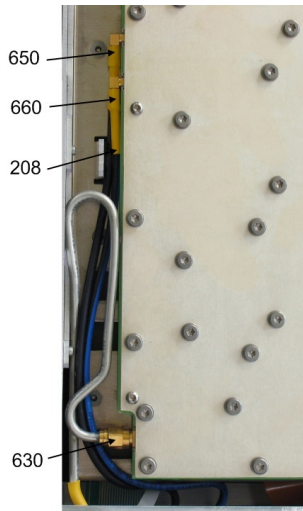

- Plug in the flex. switch board cable (403) to X112, the flex-strip cable W310 (413) to X111 and the flex-strip cable of the display (408) to X2113 from the Basis Board 2 A100 (150).

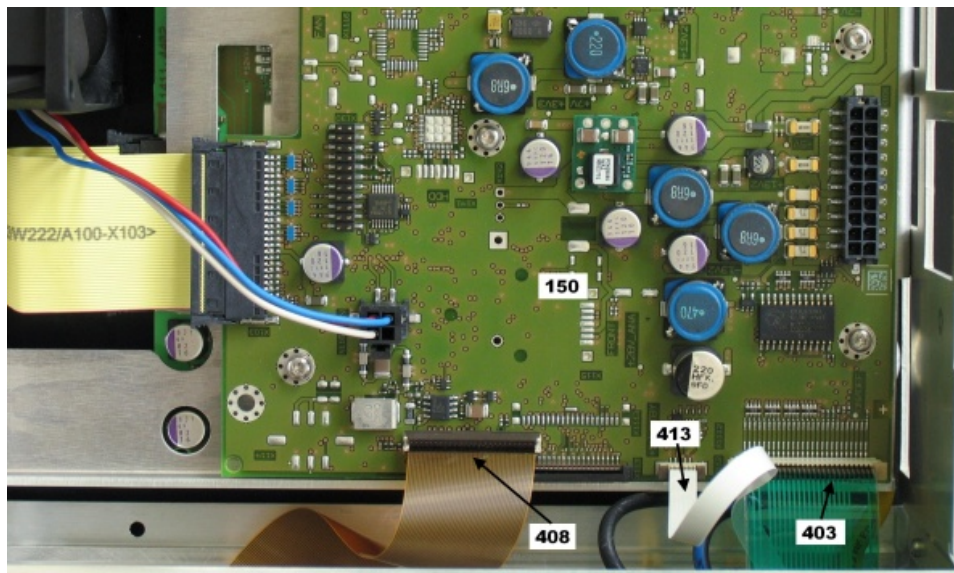

- Connect the four screws (401), two on the top side and two on the bottom side of the front unit A300 (400).

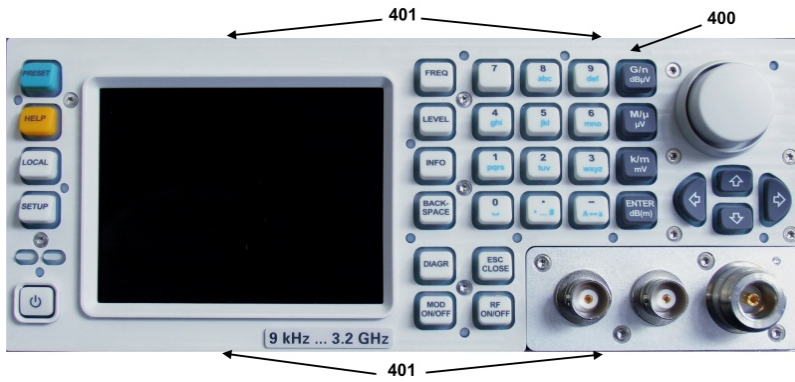

- Move the front cover R&S SMC100A (500) and the protective corner front left and right (520) and (530) back and screw it with the four screws.

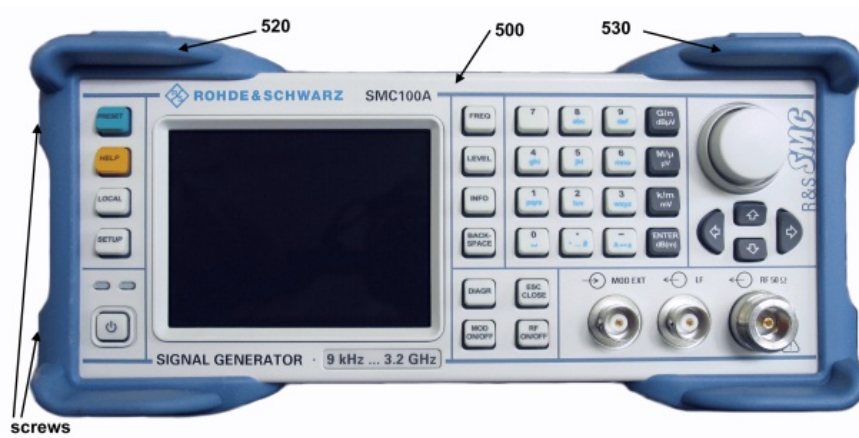

- Mounting the tube (see page 3.33).

NOTICE

Store the RF cables at a save place.
These cables are not components of the front unit.

Please screw all the RF-conductions with the Torque wrench and not with an ordinary open-end wrench

When you mount the cables, ensure their correct position in the front unit.

Replacing the TFT Display (A330), Encoder Board (A310), Flex. Switch Board, Pushbutton Board Set, the key frame and front corner plate

It is recommended to replace the front unit as a whole. Principally, it is possible to replace the individual components of the front unit (see drawing 1411.4802.01).

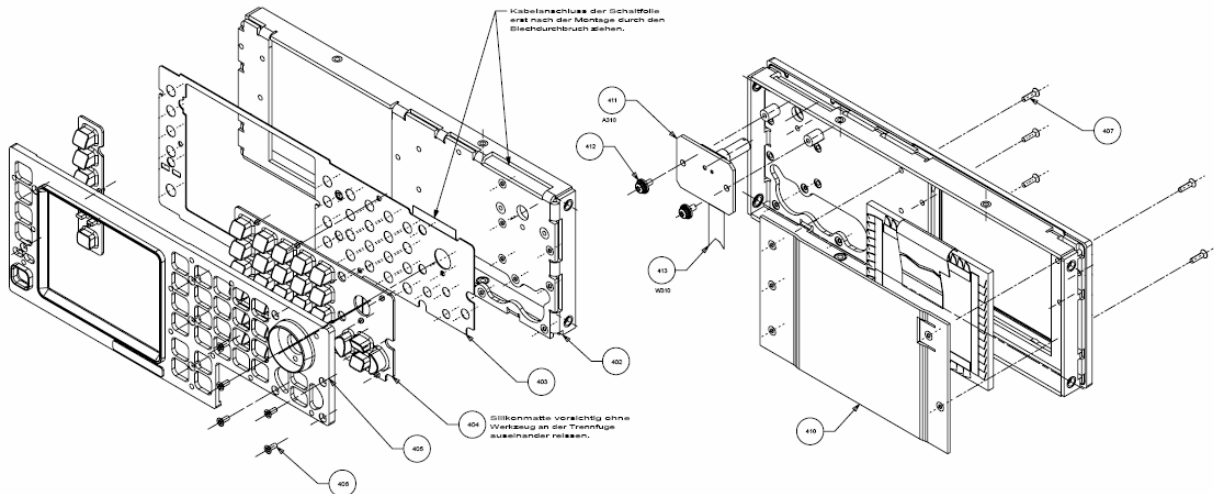

Removing the TFT Display A330

NOTICE The new Display (408) can be used only with the new front unit 1411.4802.02 and on Basis Board 1406.6700.04 with change index starting from 4.00.

- Removing the Front Unit A300 (400) (see page 3.35).
- Unscrew the five screws (407) to dismount the shielding plate (410) and remove the display (408).

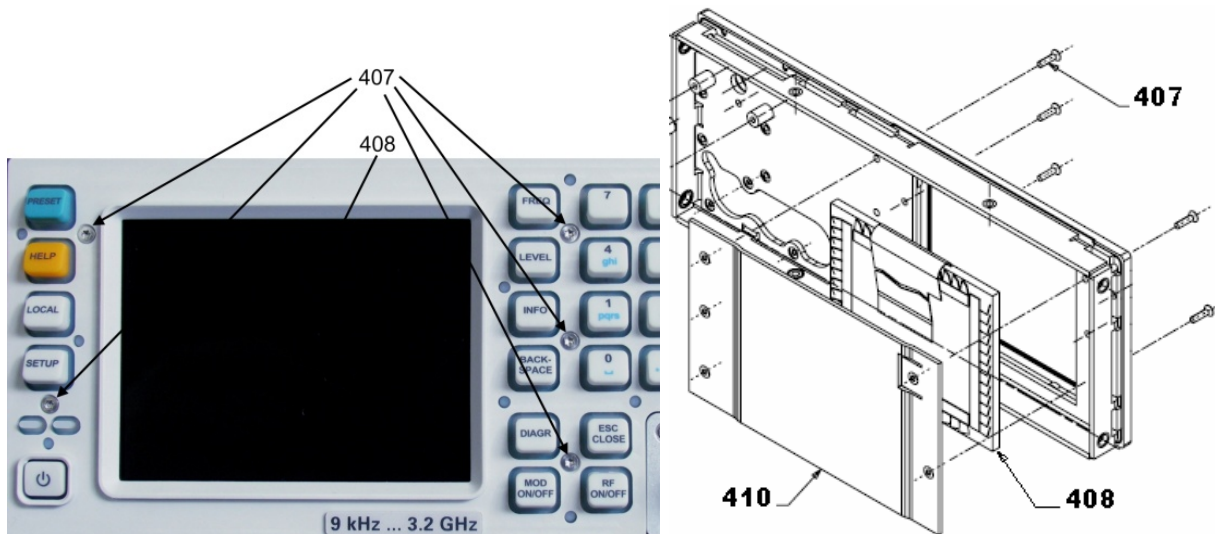

Removing the flex. switch Board, the Pushbutton-Set and the key frame

- Removing the Front Unit A300 (400) (see page 3.35).
- Remove the Knob (416) from the front side of the R&S SMC100A.



- Removing the TFT Display A330 (see above)
- Unscrew the five screws (406) and remove the key frame (405), the push-button board R&S SMC100A (404) and the flex. switch board (403)

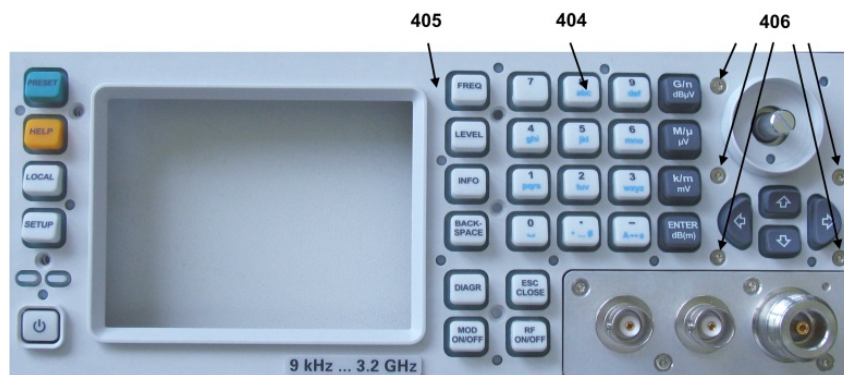

Removing the Encoder Board A310

- Removing the Front Unit A300 (400) (see page 3.35).
- Remove the Knob (416) from the front side of the R&S SMC100A.



Unscrew the two screws (412) and remove the encoder board A310 (411).

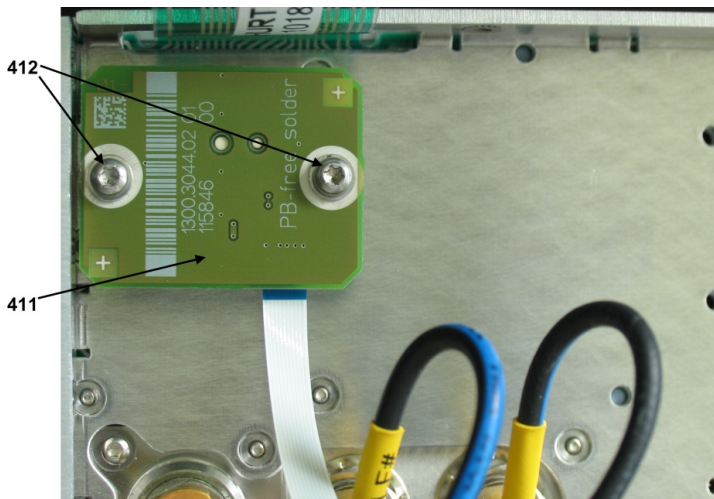

Removing the front corner plate

- Dismounting the tube (see page 3.33).
- Removing the Front Unit A300 (400) (see page 3.35).
- Unscrew the four screws (406) and remove the front corner plate (414) forwards.

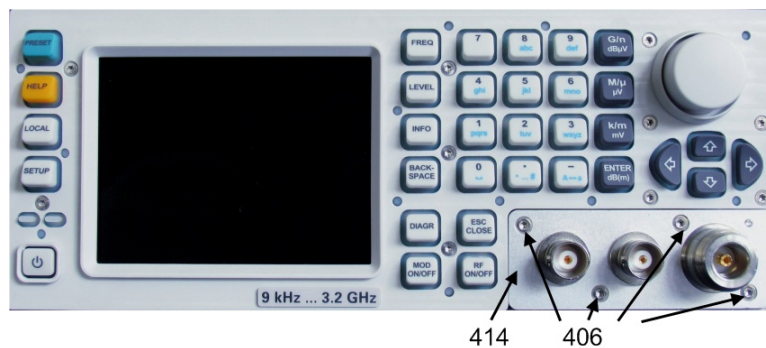

Install the Flex. switch Board, the Pushbutton Set, the key frame and the TFT Display A330

- Move the key frame (405), the push-button board R&S SMC100A (404), the flex. switch board (403) back and screw them with the five screws (406).

NOTICE Put the flex. switch board cable in the slot of the mounting through (402) after the components 403, 404 and 405 are mounted and screwed with the five screws (406).

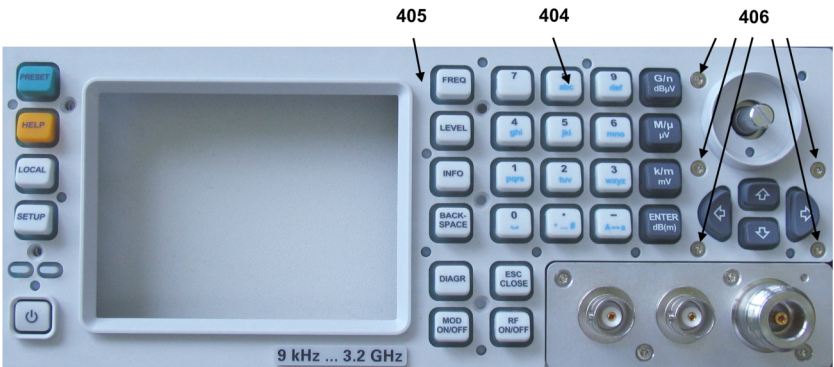
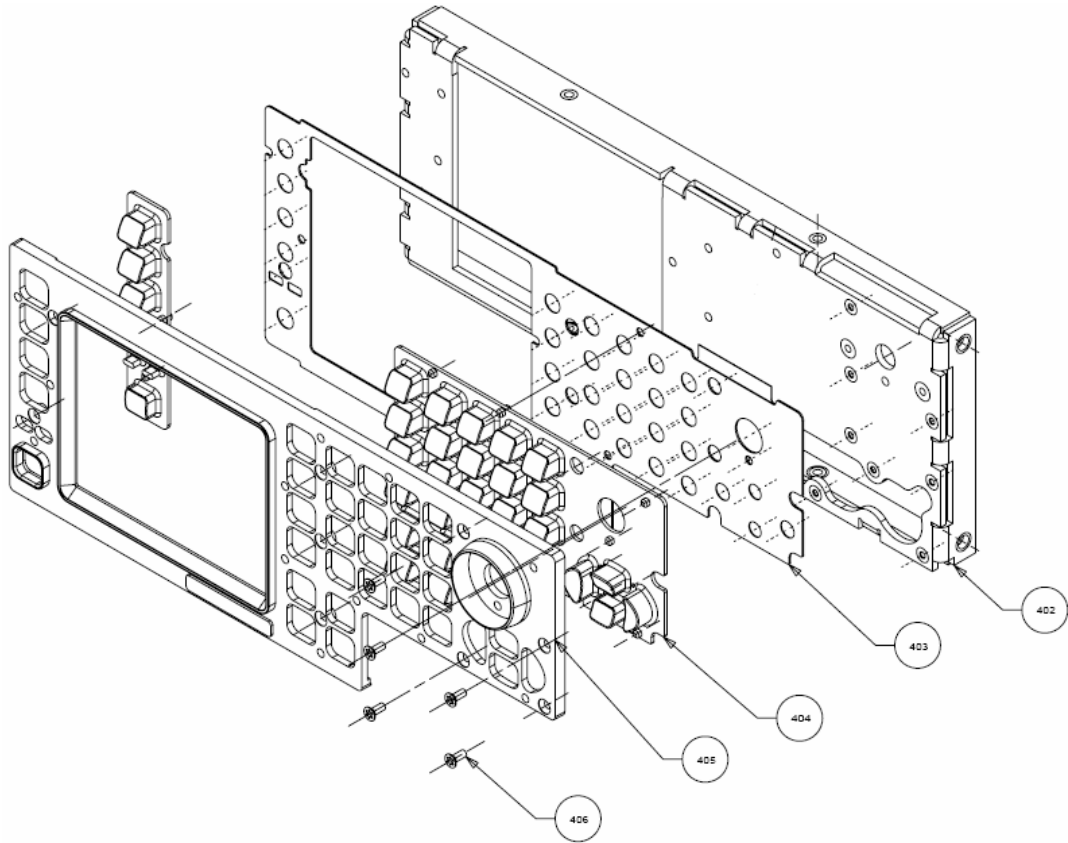

- Place the TFT display (408) and the shielding plate (410) in the mounting through (402) and screw the five screws (407).

NOTICE When installing the display, make sure it is free of dust and fingerprints.

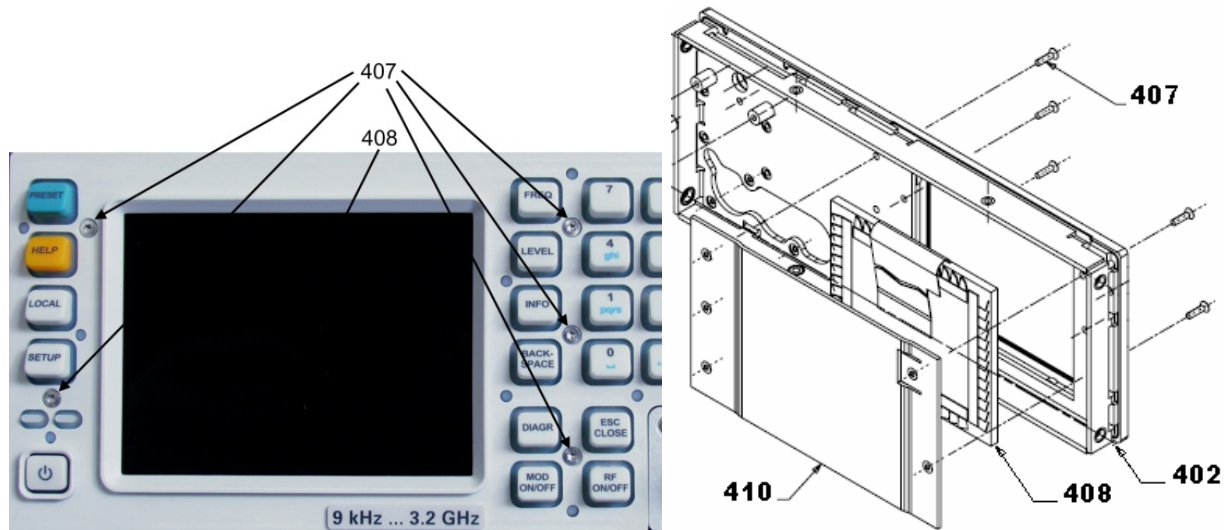

- Move the Knob (416) on the front side of the R&S SMC100A.



- Install the Front Unit A300 (400) (see page 3.37).

Install the Encoder Board A310

- Move the encoder board A310 (411) and screw it with the two screws (412).

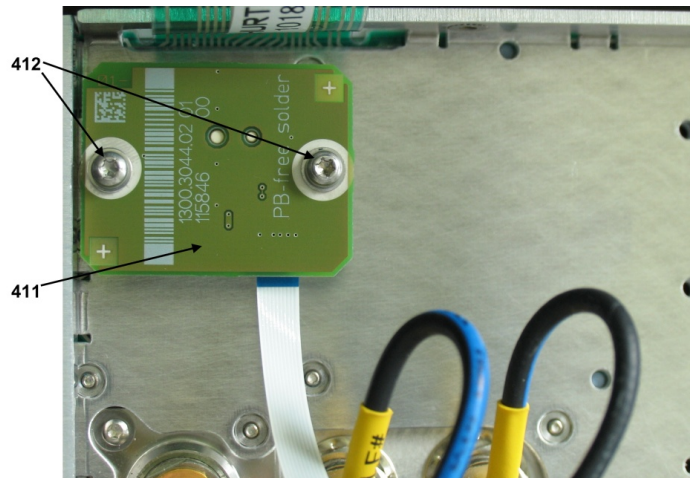

- Move the Knob (416) on the front side of the R&S SMC100A.



- Install the Front Unit A300 (400) (see page 3.37).

Install the front corner plate

- Move the front corner plate (414) backwards and screw it with the four screws (406).

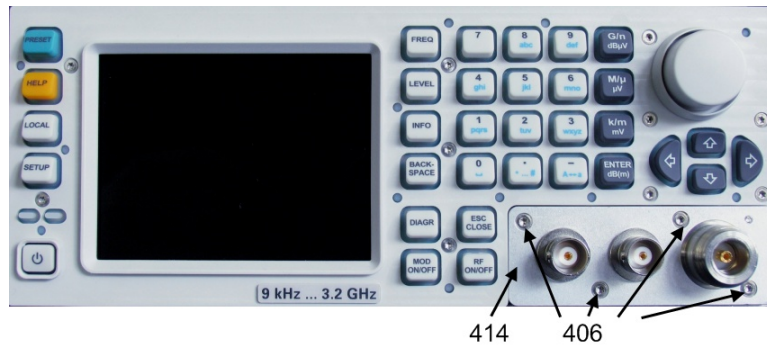

- Install the Front Unit A300 (400) (see page 3.37).
- Mounting the tube (see page 3.33).

Replacing the Power Supply A50

(see drawing 1411.4002.01).

Removing the Power Supply A50

- Switch off the instrument and pull the mains plug.
- Dismounting the tube (see page 3.33).
- Disconnect the three combinations screws (160) on the back side of the instrument.

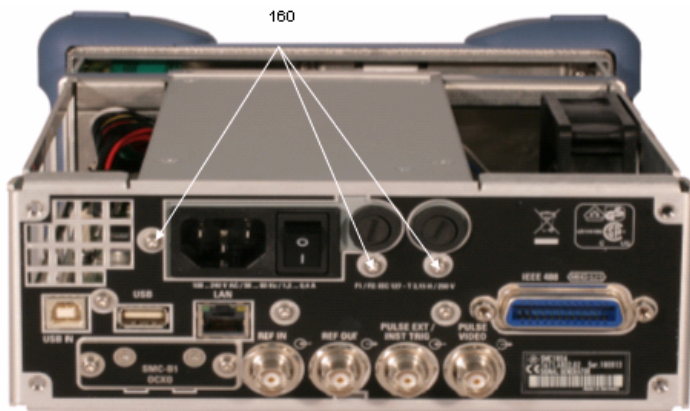

Disconnect the two screws (206) from the power supply holder 1/2 (204)

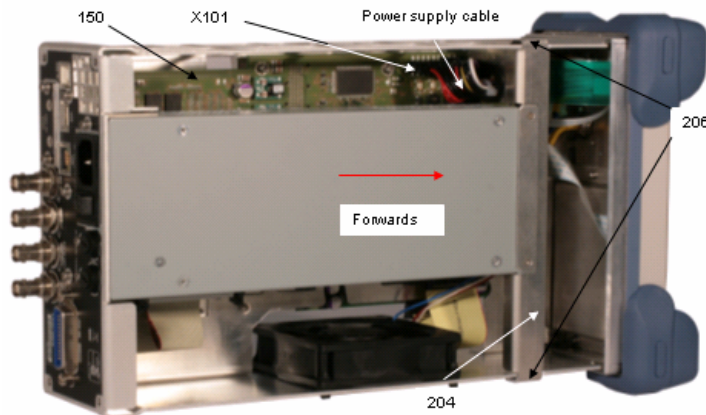

- Pull of the power supply cable from X101 from the Basis Board 2 A100 (150).
- Pull the power supply forwards and remove it.

Install the Power Supply A50

- Move the power supply into the instrument and push it backwards.

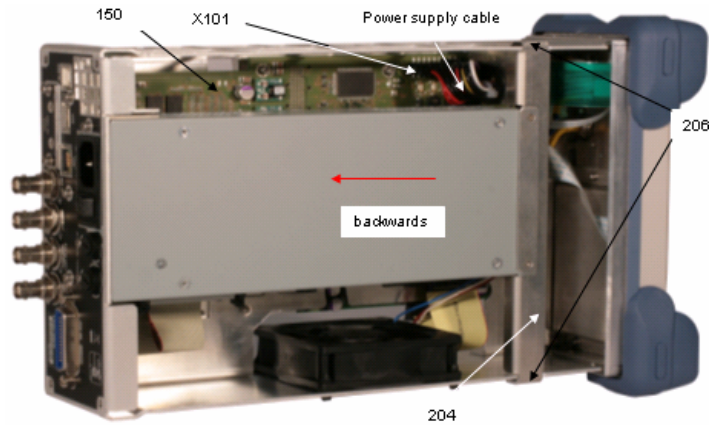

- Plug the power supply cable in X101 from the Basis Board 2 A100 (150).
- Connect the power supply holder1/2 (204) with the two screws (206) on both sides of the instrument.
- Connect the three combinations screws (160) on the back side of the instrument.
- Mounting the tube (see page 3.33).

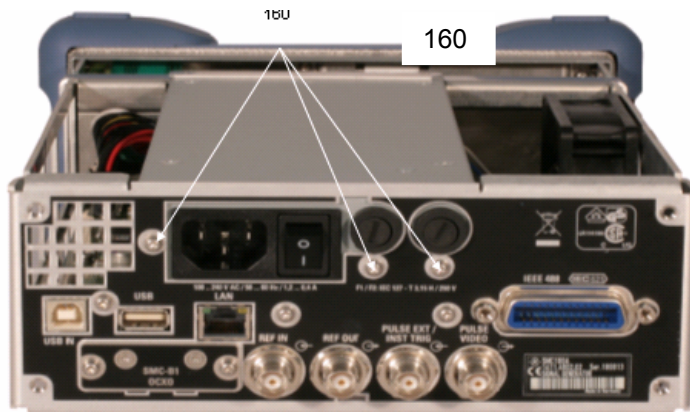

Replacing the Basis Board 2 (A100)

(see chapter 5, drawing 1411.4002.01).

Removing the Basis Board 2

- Switch off the instrument and pull the mains plug.
- Dismounting the tube (see page 3.33).
- Removing the power supply (see page 3.46).
- Unscrew the three combinations screws (160) on the back side of the instrument.

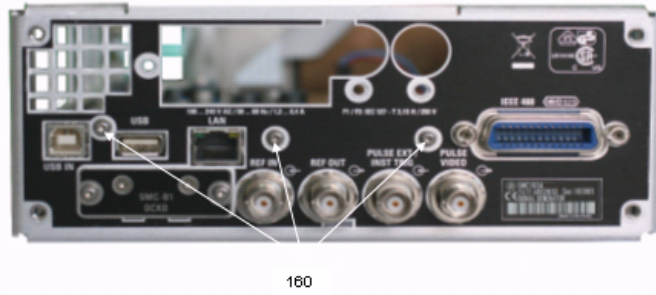

- Pull off the flex. switch board cable (403) from X112, the flex-strip cable W310 (413) from X111 and the flex-strip cable of the display (408) from X2113.

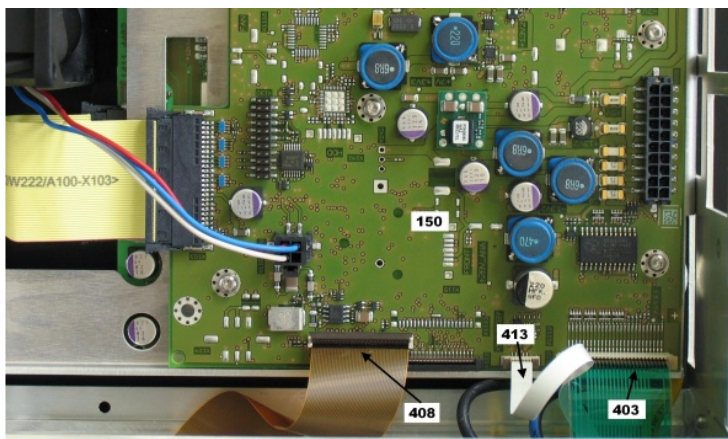

- Unscrew the six screws (160) from the Basis Board 2 A100 (150).

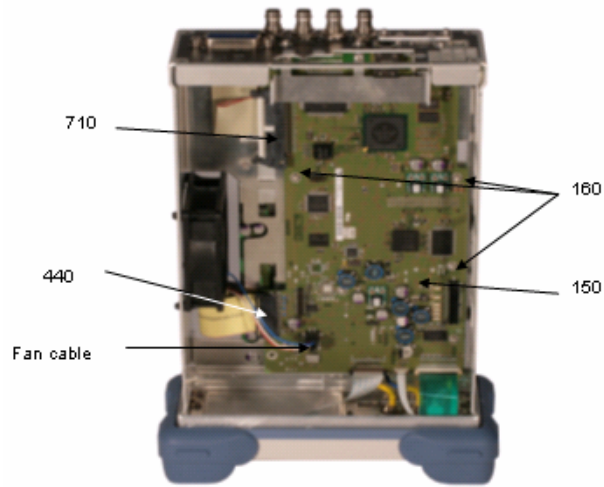

- Pull off the IEC Bus Cable W108 (710) from X108, the fan cable from X116 and W222 cable BB-RF Board (440) from X103.
- Remove the Basis Board 2 A100 (150).

Installing the Basis Board 2

- Move the Basis Board 2 A100 (150).
- Connect the IEC Bus Cable W108 (710) on X108, the fan cable on X116 and W222 cable BB-RF Board (440) on X103.

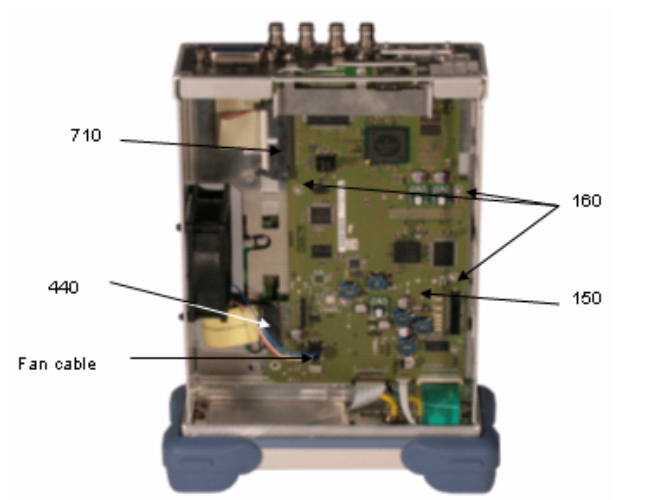

- Screw the six screws (160) to the Basis Board 2 A100 (150).
- Connect the flex. switch board cable (403) on X112, the flex-strip cable W310 (413) on X111 and the flex-strip cable of the display (408) from X2113.

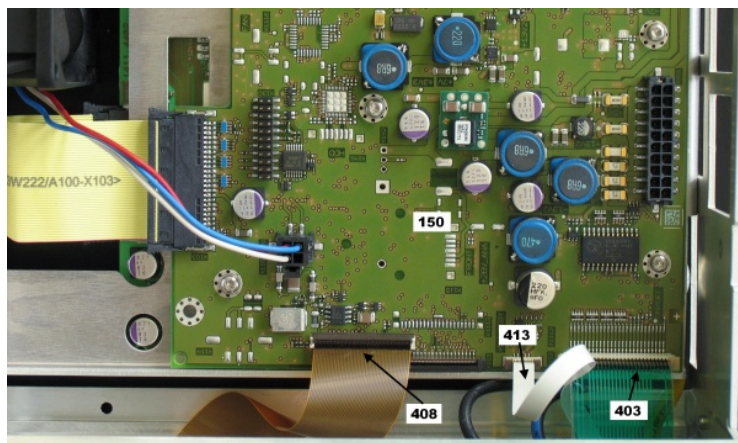

- Screw the three combinations screws (160) on the back side of the instrument.

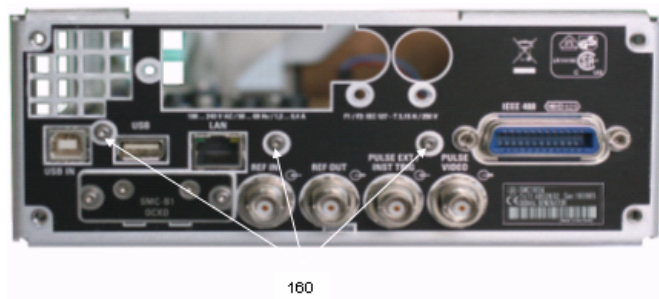

- Install the power supply (see page 3.47).
- Mounting the tube (see page 3.33).

Replacing the SIM Card A110

NOTICE When changing the Basis Board 2, you have to remove the SIM card.

The SIM card is part of your instrument and will not be replaced by Rohde & Schwarz if lost. Therefore, always keep the SIM card with you.

- Switch off the instrument and pull the mains plug.
- Dismounting the tube (see page 3.33).
- Removing the power supply (see page 3.46).
- Removing the Basis Board 2 (see 3.48).

The SIM card A110 (155) is located on the rear side of the Basis Board 2.

- Open the latch of the SIM card holder by sliding the retaining bracket toward OPEN.

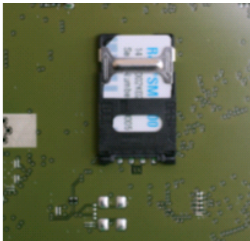

- Flip the SIM card holder upward.
- The latch of the SIM card holder is open, now remove the SIM card R&S SMC100A.

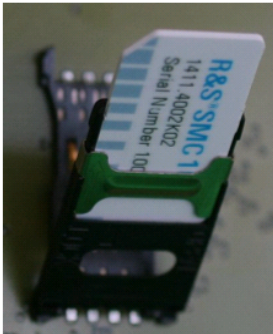

- To install the SIM card, proceed in the reverse order.

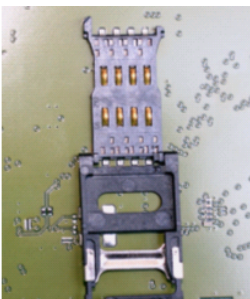

Replacing the RF-Board (A200)

(see drawing 1411.4002.01).

Removing the RF-Board

Note: If the R&S SMC-B1 (Reference Oscillator) option is installed, uninstall this option first (see page 3.57).

- Switch off the instrument and pull the mains plug.
- Dismounting the tube (see page 3.33).
- Slice up the two cable ties (208) and disconnect the cables W214 Mod Ext – RF Board (650), the W215 LF- RF Board (660) and W212 (630) and the cable BB–RF Board W222 (440).

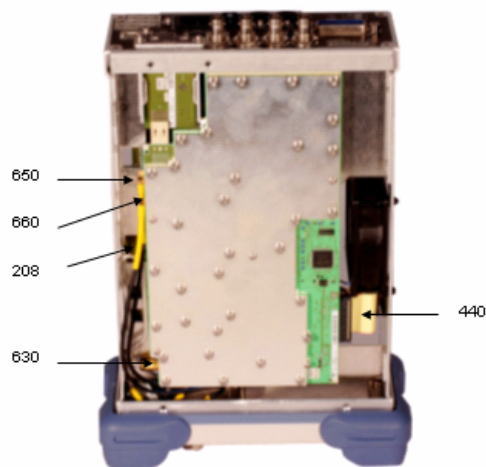

- Remove the 4 nuts of the BNC-connectors.

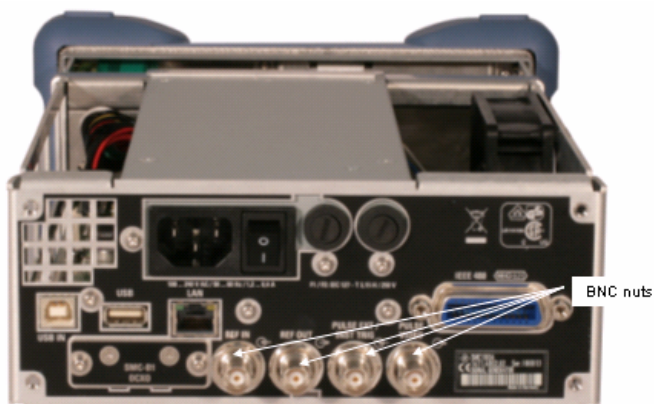

- Unscrew the 5 screws (260) from the RF-board A200 (250) and remove the board carefully.

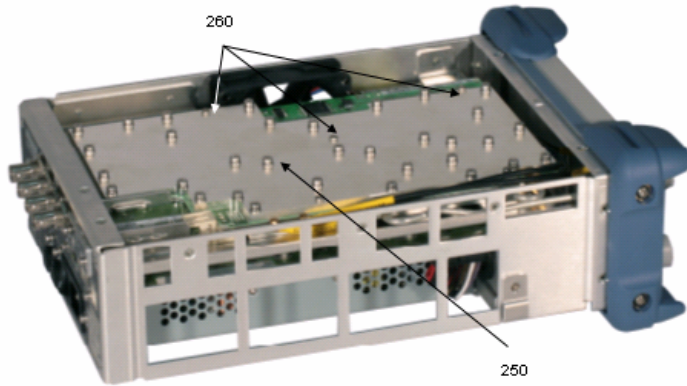

Installing the RF-Board

- Place the RF-Board A200 (250) into the R&S SMC100A in the right position and fix it with 5 screws (260).

NOTICE

Do not screw down the 5 screws, just fix them and after fixing the 4 BNC-Connector nuts you can screw down the 5 screws.

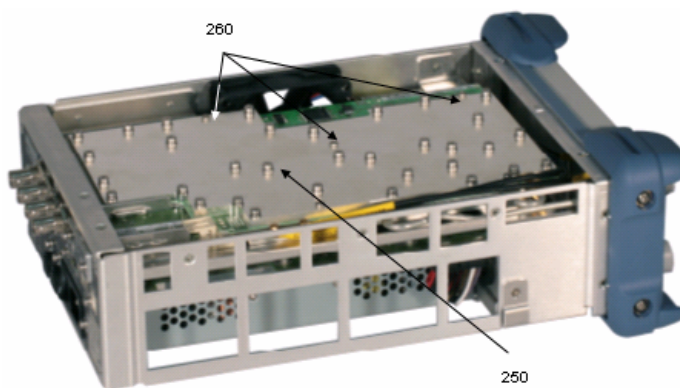

- Fix the 4 BNC-Connectors with the nuts.
- Screw the 5 screws (260) and then screw the 4 BNC-Connectors with the nuts.

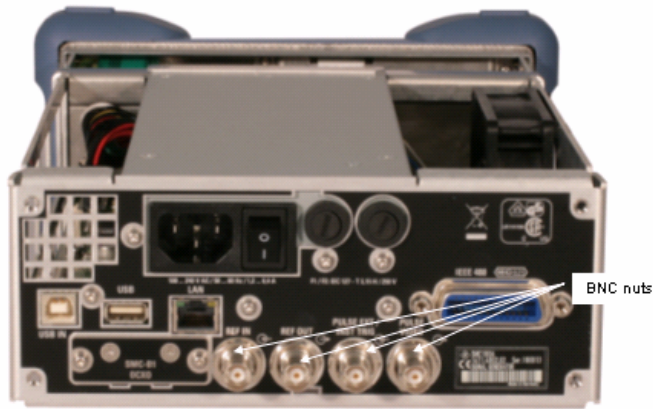

- Connect the Cables W214 Mod Ext – RF Board (420), W215 LF –RF Board (43), W212 (630) and the cable BB-RF-Board W222 (440).

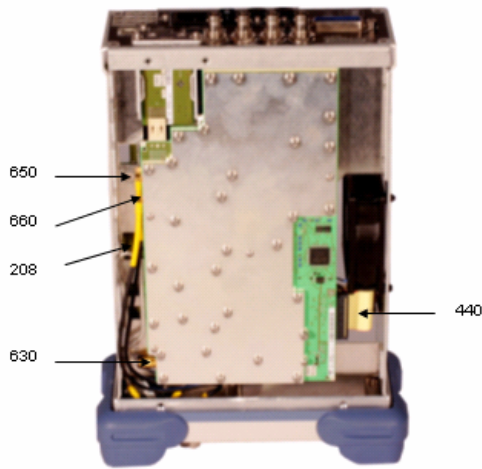

- Mounting the tube (see page 3.33).

Replacing the Fan Unit (E1)

(see drawing 1411.4002.01 and 1411.4348.01).

Removing the Fan Unit (E1)

- Switch off the instrument and pull the mains plug.
- Dismounting the tube (see page 3.33).
- Disconnect the fan cable at X116 and push the rubber pins through the trough.

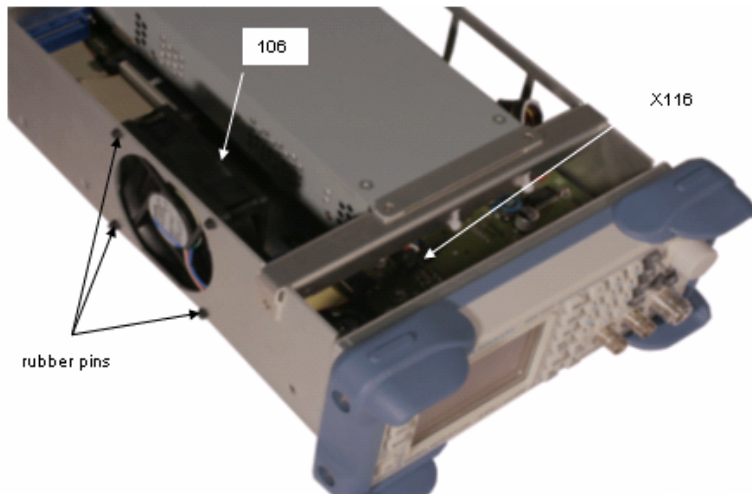

- Pull the fan unit E1 (106) upwards.

Install the Fan Unit (E1)

- Install the new fan and proceed in the reverse order.
- Cut off the unnecessary rubber from the pins which extend outside the instrument casing.

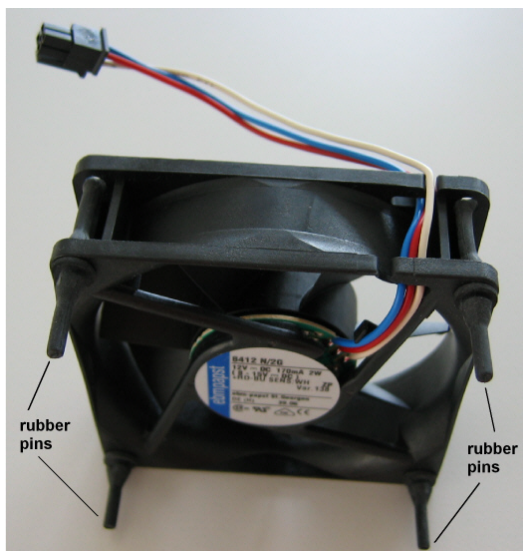

Fan Unit E1 (106), see also "[Overview of the Modules](#)", page 3.30.

Replacing the R&S SMC-B1

Install the R&S SMC-B1

- Switch off the instrument and pull the mains plug.
- Unscrew the two combinations screws (508) and remove the rear panel 2 (507).

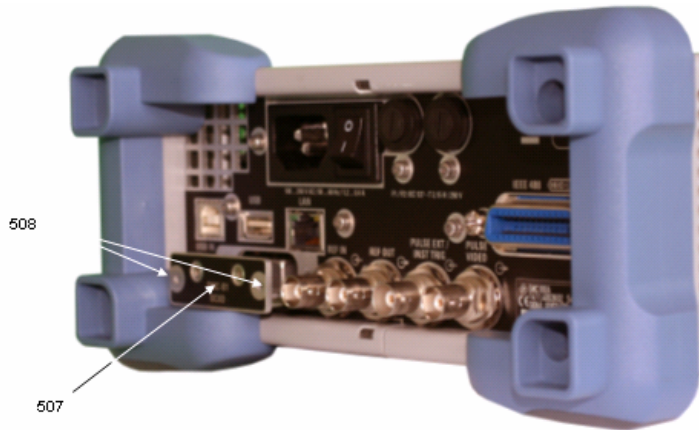

- Carefully move the reference oscillator R&S SMC-B1 forwards.



- Screw the reference oscillator R&S SMC-B1 with the 2 combinations screws (508).

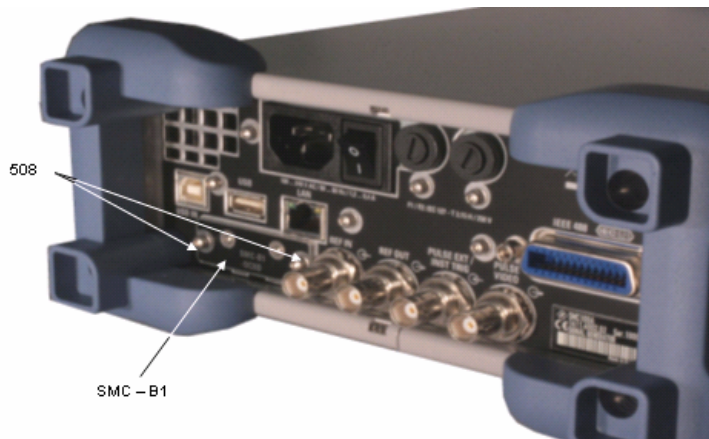

Remove the Reference Oscillator R&S SMC-B1

- Unscrew the 2 combinations screws (508).
- Carefully remove the reference oscillator R&S SMC-B1 backwards.

Contents - Chapter 4 "Software Update/Installing Options"

- 4 Software Update / Installing Options4.1**
 - Installation of New R&S SMC Firmware4.1**
 - Installing the Options4.2**
 - Hardware Options4.2
 - Software Options.....4.3

4 Software Update / Installing Options

This chapter contains information on firmware update, Linux operating system update and installing options to the R&S SMC. Additional manuals obtained together with a firmware update or with subsequently acquired options can be filed here.

NOTICE**Possible impairment of the functioning of the instrument**

The instrument is equipped with the Linux operating system. It is thus possible to install COTS software in the instrument. The use and installation of commercial off-the-shelf (COTS) software may impair the instrument function. For this reason, we recommend that you only execute programs tested by Rohde&Schwarz with regard to their compatibility with the instrument software. In certain cases, the use of these programs can impair the performance of the instrument.

The drivers and programs used in the instrument under Linux have been adapted to the test instrument. Existing instrument software must only be modified with update software released by Rohde & Schwarz.

Installation of New R&S SMC Firmware

Your R&S SMC is delivered with the latest firmware version available. Firmware updates as well as the Release Notes describing the improvements and modifications are provided on the Internet at the download site of the R&S SMC homepage <http://www.rohde-schwarz.com/product/smc100a>. This homepage always offers the latest information on your signal generator, e.g. also on **changes of the firmware update procedure**.

Firmware updates always are delivered in one single file with a filename starting with "SMC_" and ending in ".rsu". The version numbers in the filename vary with each update.

Firmware update: `SMC_x.xx.xx.rsu`

The installation of a new firmware version is performed via the USB interface. A deinstallation of the old firmware is not necessary.

The update file has to be downloaded from the Internet to a PC. From there the file should be transferred to the root directory of a memory stick which will later be plugged into the USB interface of the instrument. The firmware update is performed while the instrument is running. The new firmware will be loaded right after the update process. If the instrument "sees" a memory stick at its USB interface, it offers all versions stored in the root directory for selection. Thus, an upgrade or downgrade of the firmware is possible at any time.

Installing the firmware

NOTICE**Risk of impairment of instrument function!**

To avoid impairment of instrument functions, the update of the firmware must not be cancelled and the instrument must not be switched off during the update.

It is strongly recommended to do no downgrade below the firmware version the instrument has been delivered with.

1. Switch on the instrument and wait until it is operational.
2. Plug in the memory stick which contains the update file (previously downloaded from the Internet) to the USB interface of the instrument.
3. Wait until the software update dialog appears and confirm the update.
4. Select the firmware version to be installed with the cursor up/down keys and press the rotary knob to activate your selection. The selected version will be installed.
5. Wait until the software update completed message appears.
6. Remove USB stick and press the rotary knob to shut down instrument.
7. Power on instrument by pressing the power button.
8. When the new/updated firmware is up and running, execute internal adjustments after a warmup time of approx. 10 minutes.
 - Press the **SETUP** key on the instrument front panel, select **Internal Adjustments** and execute **Adjust All**.
This process updates internal instrument adjustments and can take several minutes. Adjustments requiring external measurement equipment are not affected by the firmware update and need not to be performed.

Installing the Options

A list of all available R&S SMC options is provided in the data sheet and on the internet <http://www.rohde-schwarz.com/product/smc100a>.

Hardware Options

Installation and replacement of hardware options is described in chapter 3 of this service manual.

Please also note the mounting instructions enclosed with the options. These mounting instructions can be filed at this place in the service manual and are thus easily available whenever they are required.

CAUTION



Danger of shock hazard

For module replacement, ensure that the instrument is switched off and disconnected from the power supply by removing the plug from the AC and DC power connector. Read all safety instructions at the beginning of this manual carefully before module replacement!

NOTICE

Danger of damage to components of the module

Protect the operational site against electrostatic discharge to avoid damage to electronic components of the modules. For details refer to the safety instructions at the beginning of this manual.

The **SETUP** **Installed Options** menu provides information on the already installed options.

Software Options

All available software options are already included in the latest firmware. They are ready to operate after they are enabled by means of a key code supplied with the option.

Only if the R&S SMC is equipped with an older firmware version, a firmware update prior to enabling the software option may be required. The information on the valid firmware versions for the purchased software option is provided together with the option.

The key code is to be entered into the **SETUP** **Install SW Option** menu.

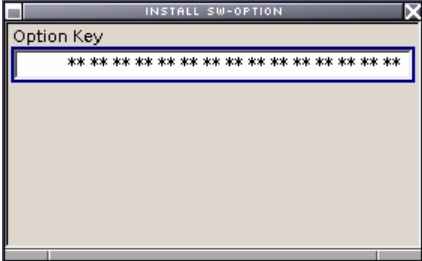

The **SETUP** **Installed Options** menu provides information on the already installed options

Contents - Chapter 5 "Documents"

- 5 Documents.....5.1
 - Spare Parts.....5.1
 - Available Power Cables5.2

5 Documents

This chapter contains the spare parts list and the documents for the complete R&S SMC unit. For general information about spare parts for our products please refer to the sheet “Procedure in Case of Service and Ordering of Spare Parts” at the beginning of this manual.

Spare Parts

The stock numbers necessary for ordering replacement parts and modules can be found in the component lists further down.

CAUTION**Danger of shock hazard**

For module replacement, ensure that the instrument is switched off and disconnected from the power supply by removing the plug from the AC and DC power connector.

Read all safety instructions at the beginning of this manual carefully before module replacement!

NOTICE**Risk of damage to the module**

When shipping a module be careful to provide for sufficient mechanical and anti-static protection.

Available Power Cables

Table 5-1 List of power cables available

Stock No.	Earthed-contact connector	Preferably used in
DS 0006.7013.00	BS1363: 1967' 10 A, 250 V complying with IEC 83: 1975 standard B2	Great Britain
DS 0006.7020.00	Type 12, 10 A, 250 V complying with SEV-regulation 1011.1059, standard sheet S 24 507	Switzerland
DS 0006.7036.00	Type 498/13, 10 A, 250 V complying with US-regulation UL 498, or with IEC 83	USA/Canada
DS 0041.4752.00	GB2099, GB1002, 10 A, 250 V approvals CCC	China
DS 0041.6232.00	JIS C 8303, 7A, 125 V AC approvals PSE (JET)	Japan
DS 0006.7107.00	Type SAA3, 10 A, 250 V, complying with AS C112-1964 Ap.	Australia
DS 0025.2365.00 DS 0099.1456.00	DIN 49 441, 10 A, 250 V, angular DIN 49 441, 10 A, 250 V, straight approvals VDE, ÖVE, CEBEC, KEMA, S, D, N, FI, LCIE, IMQ, UCIEE	Europe (except Switzerland)



R&S SMC100A

Spare Parts List

Für diese Unterlage behalten wir uns alle Rechte vor.
 Ausgedruckte Dokumente unterliegen nicht dem Änderungsdienst.
 For this document all rights are reserved.
 Printed documents are not subject to revision

Pos.-Nr. ItemNo	Menge Quantity	ME Unit	El.Kennz Ref.Des.	Benennung / Bezeichnung Designation	Z	Sachnummer Stock No.	Ersatzteil Subst.part	BA	VH
				ACHTUNG EGB/ATTENTION ESD *VARIANTENERKLAERUNG *EXPLANATION OF MODELS VAR02=GRUNDVARIANTE MOD02=BASIC MODEL					
7 0		S		ZS ERSATZTEILLISTE VORHANDEN SPARE PARTS LIST AVAILABLE Ersatzteilliste SMC ID.Nr. 1411.4031.01 ST		0999.9684.00		M	O
100 1		S		ZM CHASSIS SMC CHASSIS SMC	Z	1411.4348.02		M	
150 1		S	A100	ED BASISBOARD 2 BASIS BOARD 2	Z	1406.6700.04	X	M	
155 1		S	A110	HS CHIPKARTE SMC100A CHIPCARD SMC100A	Z	1411.4883.00		M	
160 10		S		VS 6900/ISR-M2.5X8-A2 COMBINATION SCREWS		0041.1653.00		B	T
170 1		S		MZ USB / NETZTEILWINKEL USB/POWER SUPPLY HOLDER	Z	1411.4331.00		M	
180 2		S		VS 7985/ISR-M3X6-A4-PA SCREW		1148.2630.00		B	O
200 1		S	A50	NJ SCHALTNETZTEIL AC90-264V POWER SUPPLY		1406.7336.00	X	B	B
204 1		S		MZ NETZTEILHALTERUNG 1/2 POWER SUPPLY HOLDER	Z	1411.4277.00		M	
206 2		S		VS 965/ISR-M2.5X4-A4-PA 965/ISR-M2.5X4-A4-PA		1148.3271.00		B	T
207 1		S		MZ UNTERLEGBLECH HOLDER	Z	1411.4260.00		M	
208 3		S		DZ KABELBI.RD 1 BIS 25 B2 CABLETIE		0015.9038.00		B	O
210 2		S		VS 965/ISR-M2X5-A4-PA 965/ISR-M2X5-A4-PA		1148.3265.00		B	O
250 1		S	A200	ED RF BOARD RF BOARD	Z	1411.4402.02	X	M	
260 5		S		VS 7985/ISR-M2.5X16-A4-PA 7985/ISR-M2.5X16-A4-PA		1148.2869.00		B	T
270 4		S		FJ FAECHERSCHEIBE SERRATED LOCKWASHER		3583.1578.00		B	O
280 4		S		FJ MUTTER HEX 14 1/2 -28UNEF HEX 14 NUT 1/2 -28UNEF		3583.1561.00		B	B
400 1		S	A300	ZM FRONTEINHEIT SMC NEUES DISPLAY FRONT UNIT SMC	Z	1411.4802.02	X	M	
401 4		S		VS 965/ISR-M2.5X4-A4-PA 965/ISR-M2.5X4-A4-PA		1148.3271.00		B	T
440 1		S	W222	DY KABEL BB-RF-BOARD CABLE BB-RF-BOARD	Z	1406.8110.00		M	
500 1		S		KB FRONTHAUBE SMC BEDRUCKT FRONT COVER SMC PRINTED	Z	1411.4683.00		M	
507 1		S		KB RÜCKWAND 2 SMC BEDRUCKT REAR PANEL 2 SMC PRINTED	Z	1411.4302.00		M	



ROHDE & SCHWARZ

Benennung/Designation

SMC100A SIGNAL GENERATOR
SMC100A SIGNAL GENERATOR

Sprach./Lang
de en

Ä.I. / C.I
09.00

Blatt/Sheet
1 of 2

Dokument Nr. / Document No.

1411.4002.01 ST

SMC100A

Datum/
Date 2010-03-23

Abt. /
Dept. 1GPK

Name /
Name BU

Für diese Unterlage behalten wir uns alle Rechte vor.
 Ausgedruckte Dokumente unterliegen nicht dem Änderungsdienst.
 For this document all rights are reserved.
 Printed documents are not subject to revision

Pos.-Nr. ItemNo	Menge Quantity	ME Unit	El.Kennz Ref.Des.	Benennung / Bezeichnung Designation	Z	Sachnummer Stock No.	Ersatzteil Subst.part	BA	VH
508	2	S		VS 6900/ISR-M2.5X8-A2 COMBINATION SCREWS		0041.1653.00		B	T
510	1	S		KR BW2 TUBUS 2E1/2T350 SMC100A BW2 TUBE 2HU1/2D350 SMC100A	Z	1411.4383.00		M	
520	1	S		KR BW2-SCHUTZECK VO.LI.2E HART PROTECTIVE CORNER FRONT LEFT		1096.6618.00		B	O
530	1	S		KR BW2-SCHUTZECK VO.RE.2E HART PROTECTIVE CORNER FRONT RIGHT 2HU		1096.6624.00		B	O
540	1	S		KR BW2-SCHUTZECK HI.LI.2E HART PROTECTIVE COVER REAR LEFT 2HU		1096.6630.00		B	O
550	1	S		KR BW2-SCHUTZECK HI.RE.2E HART PROTECTIVE COVER REAR RIGHT 2HU		1096.6647.00		B	O
700	1	S		HS FIRMWARE SMC FIRMWARE SMC	Z	1411.4502.00		M	
705	1	S		HS FONT MICROSOFT ARIAL WGL FONT MICROSOFT ARIAL WGL		3584.9795.00		B	O
710	1	S	W108	DY IEC BUS CABLE IEC BUS CABLE	Z	1411.4760.00		M	
720	1	S		FM SCHUTZKAPPE F.24POL.BU PROTECION CAP		0836.8850.00		B	V
730	1	S		OS KLEBESCHILD GPIB LABEL GPIB		1411.4548.00		M	

 ROHDE & SCHWARZ	Benennung/Designation SMC100A SIGNAL GENERATOR SMC100A SIGNAL GENERATOR			Sprach./Lang de en	Ä.I. / C./ 09.00	Blatt/Sheet 2 of 2	
	SMC100A	Datum/ Date	2010-03-23	Abt. / Dept.	1GPK	Name / Name	BU

Für diese Unterlage behalten wir uns alle Rechte vor.
 Ausgedruckte Dokumente unterliegen nicht dem Änderungsdienst.
 For this document all rights are reserved.
 Printed documents are not subject to revision

Pos.-Nr. ItemNo	Menge Quantity	ME Unit	El.Kennz Ref.Des.	Benennung / Bezeichnung Designation	Z	Sachnummer Stock No.	Ersatzteil Subst.part	BA	VH
				ACHTUNG EGB/ATTENTION ESD *VARIANTENERKLAERUNG *EXPLANATION OF MODELS VAR02=GRUNDVARIANTE MOD02=BASIC MODEL					
101	1	S		MZ HALTEWINKEL 1/2 HOLDER 1/2	Z	1411.4254.00		M	
102	1	S		KB GERAETEWANNE SMC BEDRUCKT REAR PANEL SMC BEDRUCKT	Z	1411.4319.00		M	
103	1	S		KR BW2-FRONTRAHMEN 2E 1/2 FRONTFRAME		1096.0355.00		M	T
104	12	S		VN BLINDNIET 3.2X5.8 ST BLIND RIVET 3.2X5.8 ST		1096.4821.00		B	O
105	1.2	M		WG HF-DICHT O-PROF 2.0 SI SEALING		0396.1035.00		B	T
106	1	S	E1	DX LUEFTEREINHEIT FAN UNIT	Z	1406.6330.00		M	
107	2	S		MZ Dichtungsfeder L=12.05 MZ SEAL SPRING L=12.05	Z	1143.8881.00		M	

	Benennung/Designation CHASSIS SMC CHASSIS SMC			Sprach./Lang de en	Ä.I. / C./ 06.00	Blatt/Sheet 1 of 1
	Datum/ Date 2008-05-28			Abt. / Dept. 1GPK	Name / Name MS	Dokument Nr. / Document No. 1411.4348.01 ST

Für diese Unterlage behalten wir uns alle Rechte vor.
 Ausgedruckte Dokumente unterliegen nicht dem Änderungsdienst.
 For this document all rights are reserved.
 Printed documents are not subject to revision

Pos.-Nr. ItemNo	Menge Quantity	ME Unit	El.Kennz Ref.Des.	Benennung / Bezeichnung Designation	Z	Sachnummer Stock No.	Ersatzteil Subst.part	BA	VH
				ACHTUNG EGB/ATTENTION ESD *VARIANTENERKLAERUNG *EXPLANATION OF MODELS VAR02=GRUNDVARIANTE MOD02=BASIC MODEL					
402	1	S		ZN MONTAGEWANNE SMC MOUNTING THROUGH	Z	1411.4825.00		M	
403	1	S	A320	SF SCHALTFOLE SMC FLEX. SWITCH BOARD SMC		1411.4848.00		B	B
404	1	S		SF SILIKONMATTE SMC PUSH-BUTTON BOARD SMC		1411.4654.00		B	B
405	1	S		MM TASTATURRAHMEN SMC KEY FRAME		1411.4819.00		B	B
406	9	S		VS 965/ISR-M2X5-A4-PA 965/ISR-M2X5-A4-PA		1148.3265.00		B	O
407	5	S		VS 965/ISR-M2X8-A4 965/ISR-M2X8-A4		0041.1601.00		B	V
408	1	S	A330	ND TFT 3.5 QVGA DRGB LED 180MM KABEL TFT 3.5 QVGA DRGB LED 180MM		3586.0172.00		B	T
409	4	S		EK KONTAKTFEDER CONTACT SPRING	Z	1406.7713.00		M	
410	1	S		ZN SCHIRMBLECH SHIELDING	Z	1411.4831.00		M	
411	1	S	A310	ED ENCODER BOARD ENCODER BOARD	Z	1300.3044.02		M	O
412	2	S		VS 6900/ISR-M2.5X6-A2 COMBINATION SCREWS		1148.3059.00		B	T
413	1	S	W310	DF FLEX-STRIP 10P. R=0.5 FLEX-STRIP		1146.9150.00		B	B
414	1	S		ZM FRONTANSCHLUSSPLATTE FRONT CONNECTOR PLATE	Z	1411.4748.00		M	
415	1	S		OK DREHKNOPF RD20 KNOB		2112.6131.00		B	B

 ROHDE & SCHWARZ	Benennung/Designation FRONTEINHEIT SMC NEUES DISPLAY FRONT UNIT SMC			Sprach./Lang de en	Ä.I. / C./ 01.00	Blatt/Sheet 1 of 1
	SMC	Datum/ Date	2010-03-11	Abt. / Dept.	1ZKS	Name / Name
Dokument Nr. / Document No.						1411.4802.01 ST

Für diese Unterlage behalten wir uns alle Rechte vor.
 Ausgedruckte Dokumente unterliegen nicht dem Änderungsdienst.
 For this document all rights are reserved.
 Printed documents are not subject to revision

Pos.-Nr. ItemNo	Menge Quantity	ME Unit	El.Kennz Ref.Des.	Benennung / Bezeichnung Designation	Z	Sachnummer Stock No.	Ersatzteil Subst.part	BA	VH
				ACHTUNG EGB/ATTENTION ESD					
620	1	S		MF BUCHSENPLATTE SMC SOCKET PLATE SMC		1411.4648.00		M	
630	1	S	W212	DW HF KABEL W212 RF FRONT (L) HF CABLE W212 RF FRONT (L)	Z	1411.4390.00		M	
640	1	S		VS 7985/ISR-M2X4-A4-PA 7985/ISR-M2X4-A4-PA		1148.2698.00		B	O
645	1	S		VS DIN125-A2.5-A4 WASHER DIN125		0082.4657.00		B	V
650	1	S	W214	DV KABEL W214 MOD EXT - RFBOARD CABLE W214 MOD EXT - RFBOARD	Z	1406.8149.00		M	
660	1	S	W215	DV KABEL W215 LF - RFBOARD CABLE W215 LF - RFBOARD	Z	1406.8132.00		M	

 ROHDE & SCHWARZ	Benennung/Designation FRONTANSCHLUSSPLATTE FRONT CONNECTOR PLATE			Sprach./Lang de en	Ä.I. / C./ 03.00	Blatt/Sheet 1 of 1
	Datum/ Date	2008-07-18	Abt. / Dept.	1GPK	Name / Name	WB



R&S SMC100A

Mechanical Drawings

Nicht dargestellt: Pos. 510 (Tubus)

Not shown: Pos. 510 (Tube)

mittig in Leserichtung
auf Pos. 720 aufkleben

auf IEC-Buchse
aufstecken wenn
Option SMC-K4 nicht
aktiviert ist

I

B

C

D

E

F

G

H

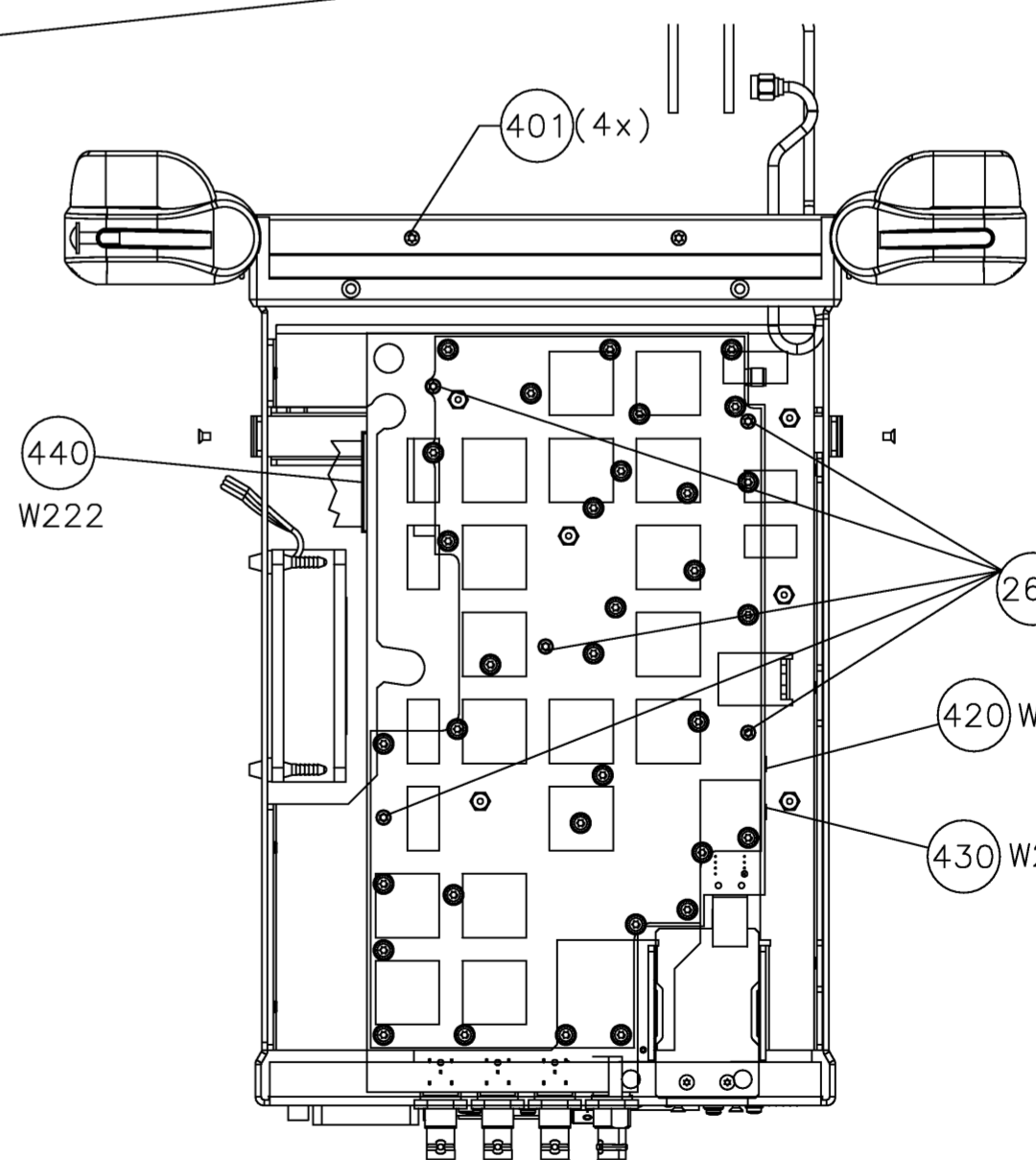
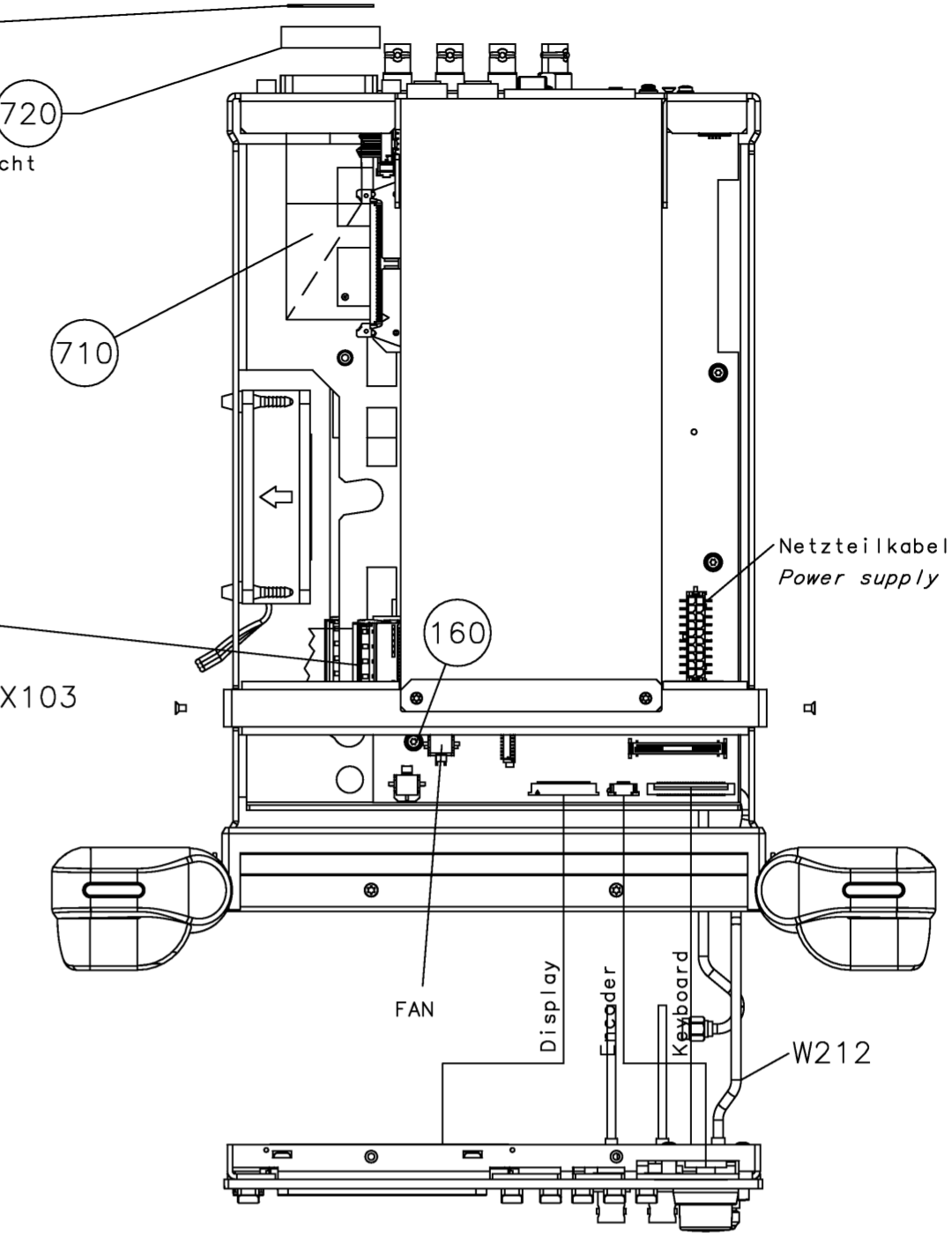
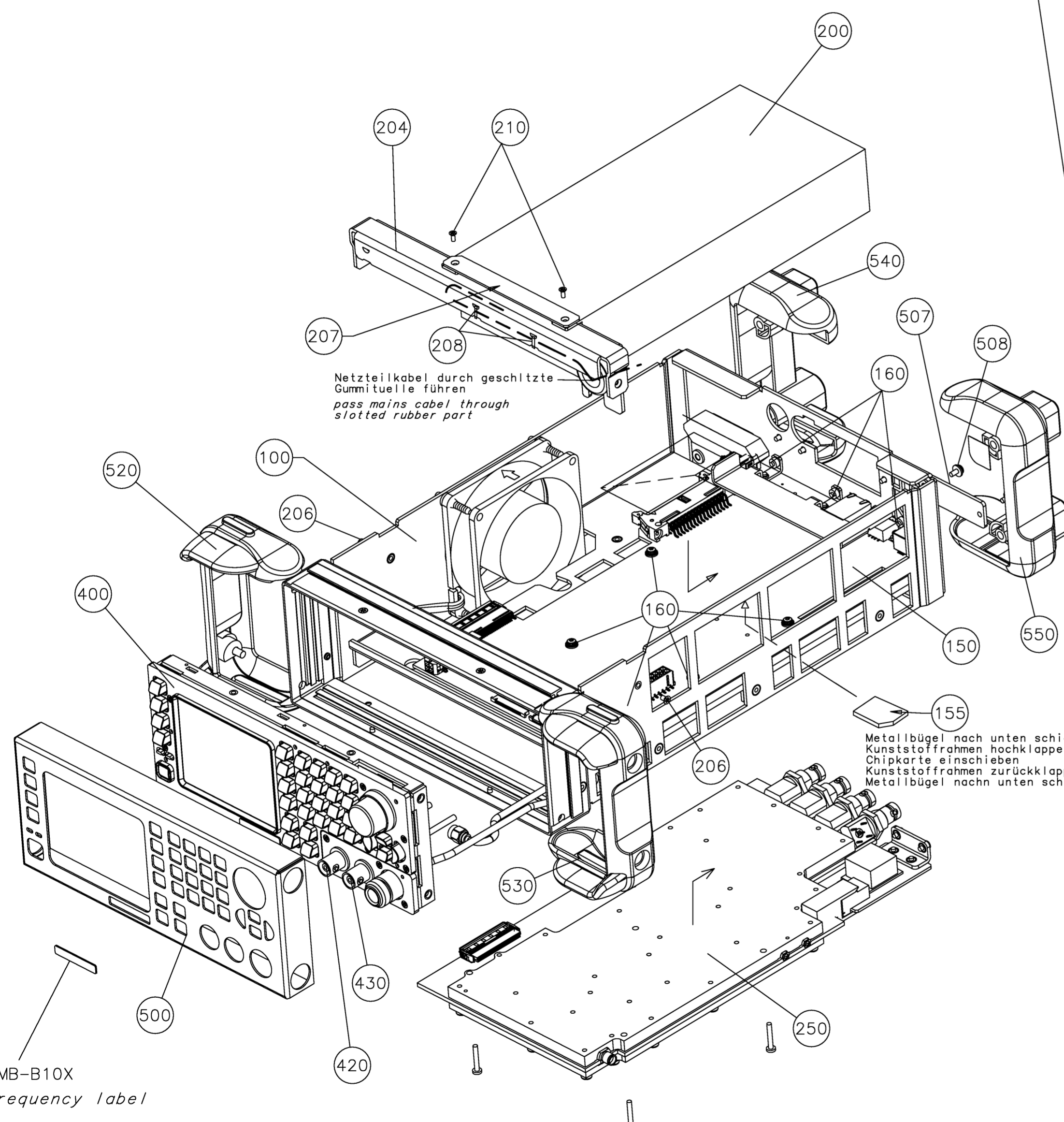

Für dieses Dokument behalten wir uns alle Rechte vor
For this document all rights are reserved

Projektions-
methode
Projection
Method

SMB-B10X
frequency label

Maßstab Scale	Toleranz Tol.	Werkstoff Material	Sprache / Lang. / Ael. / C.I.	Blatt / Sh.
ROHDE&SCHWARZ	Benennung / Designation	SMC100A SIGNAL GENERATOR SMC100A SIGNAL GENERATOR	de en	04.00 1
SMC100A	Datum Date	Abteilung Dept.	Name Name	ms
		16PK		1411.4002.01 D

Für dieses Dokument behalten wir uns alle Rechte vor
 For this document all rights are reserved

Projektions-
 methode
 Projection
 Method

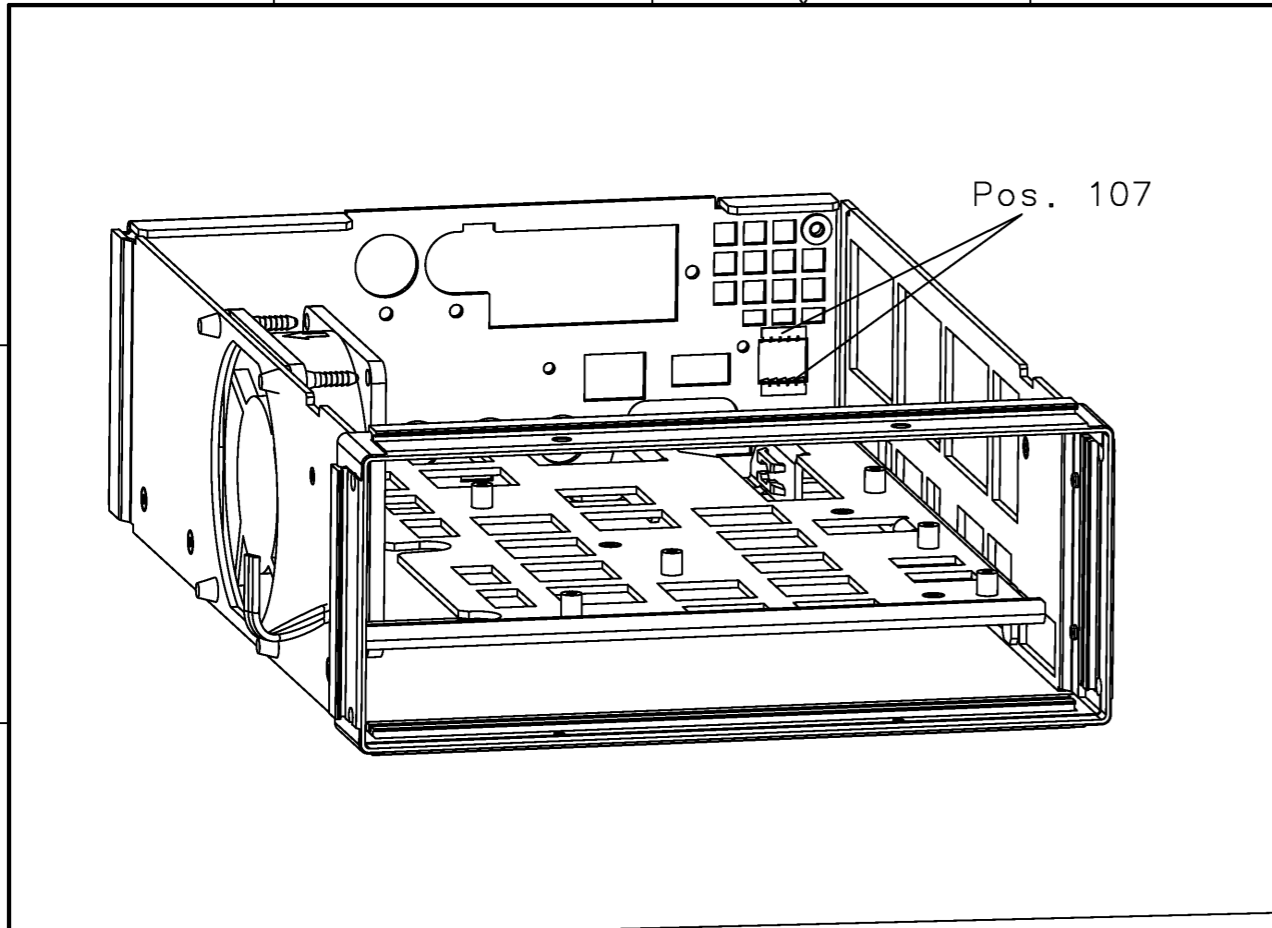

Ansicht von oben, rechts

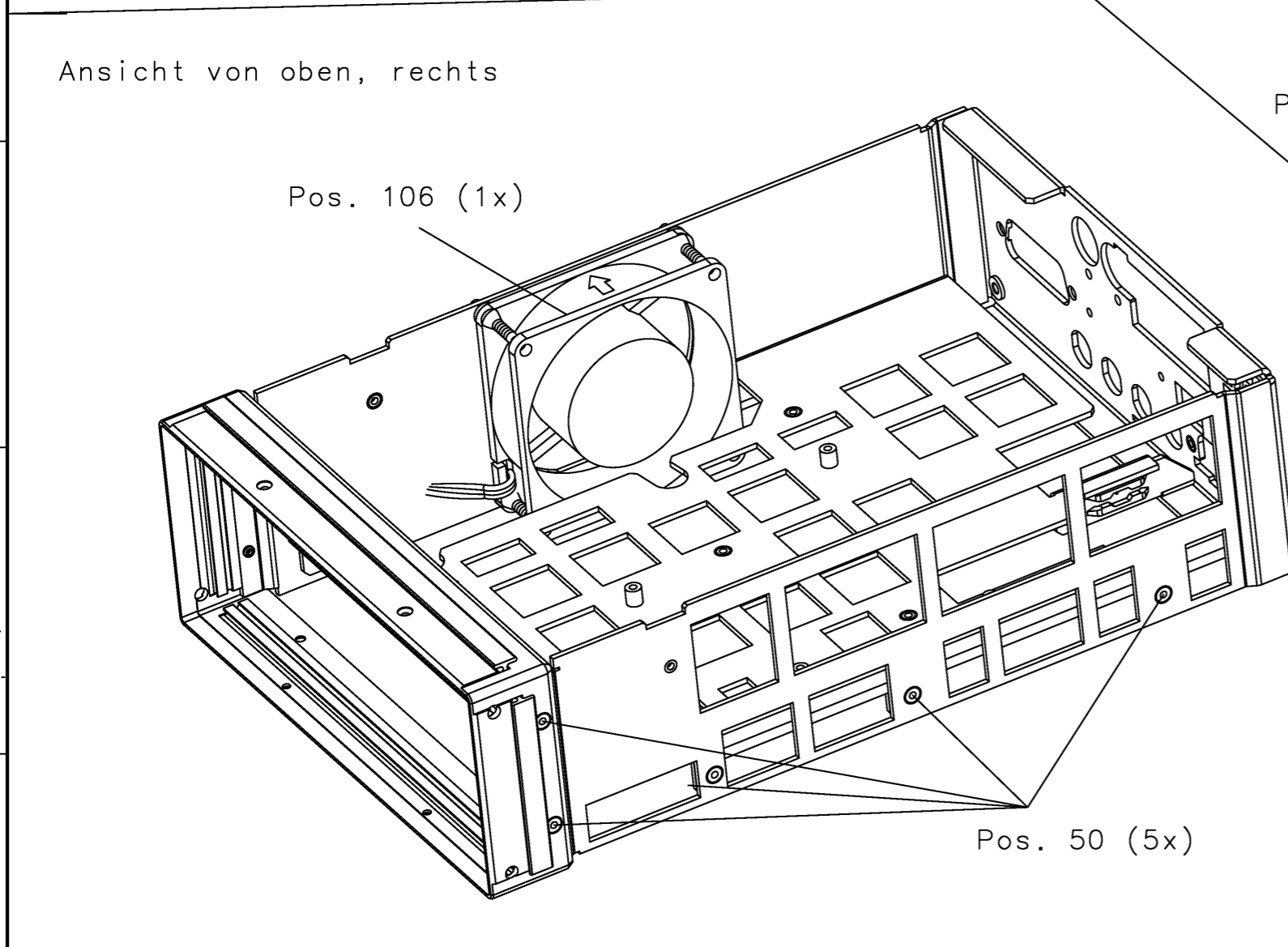

Pos. 50 (5x)

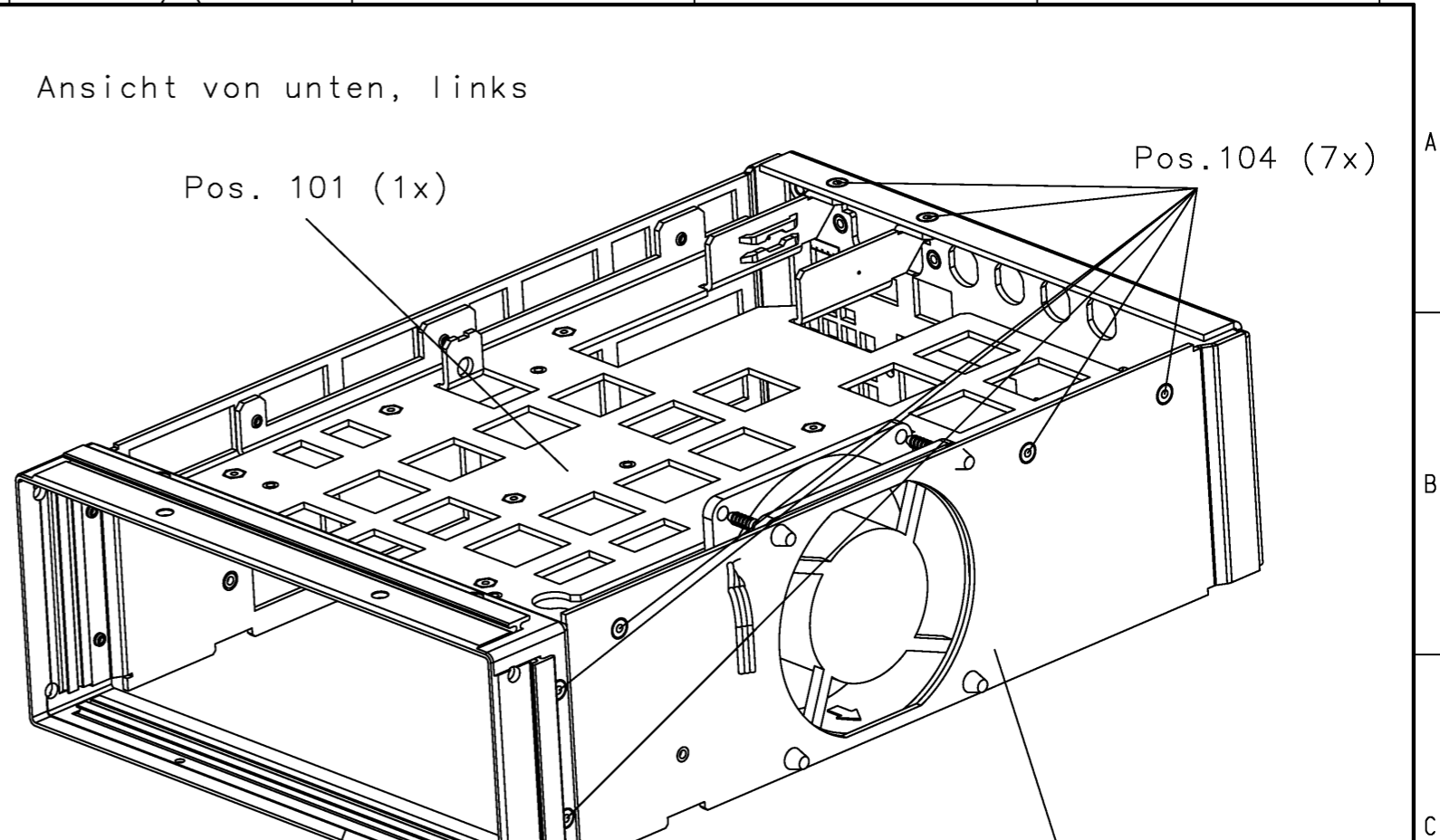

Ansicht von unten, links

2x 0,6m Dichtschnur Pos.105
 -Fronteinheit (innen, vorne)
 -Tubuskontaktierung (aussen, hinten)
 in jeweilige Nut eindrücken.
 Enden mit kleinen Punkten
 Silicon gegen Ausfransen sichern

Maßstab Scale	1:2	Toleranz Tol.	Werkstoff Material	Sprache / Lang. Ael. / C.I.	Blatt / Sh.
ROHDE&SCHWARZ		CHASSIS SMC CHASSIS SMC		de en	05.00
Datum Date		Abteilung Dept.		Zeichn.Nr. / Drawing No.	
2008-02-28		1GPK		1411.4348.01	
		Name Name		D	
		ms			

NX

Für dieses Dokument behalten wir uns alle Rechte vor
For this document all rights are reserved

Projektionsmethode
Projection Method

Kabelanschluss der Schaltfolie
erst nach der Montage durch den
Blechdurchbruch ziehen.

Silikonmatte vorsichtig ohne
Werkzeug an der Trennfuge
auseinander reißen.

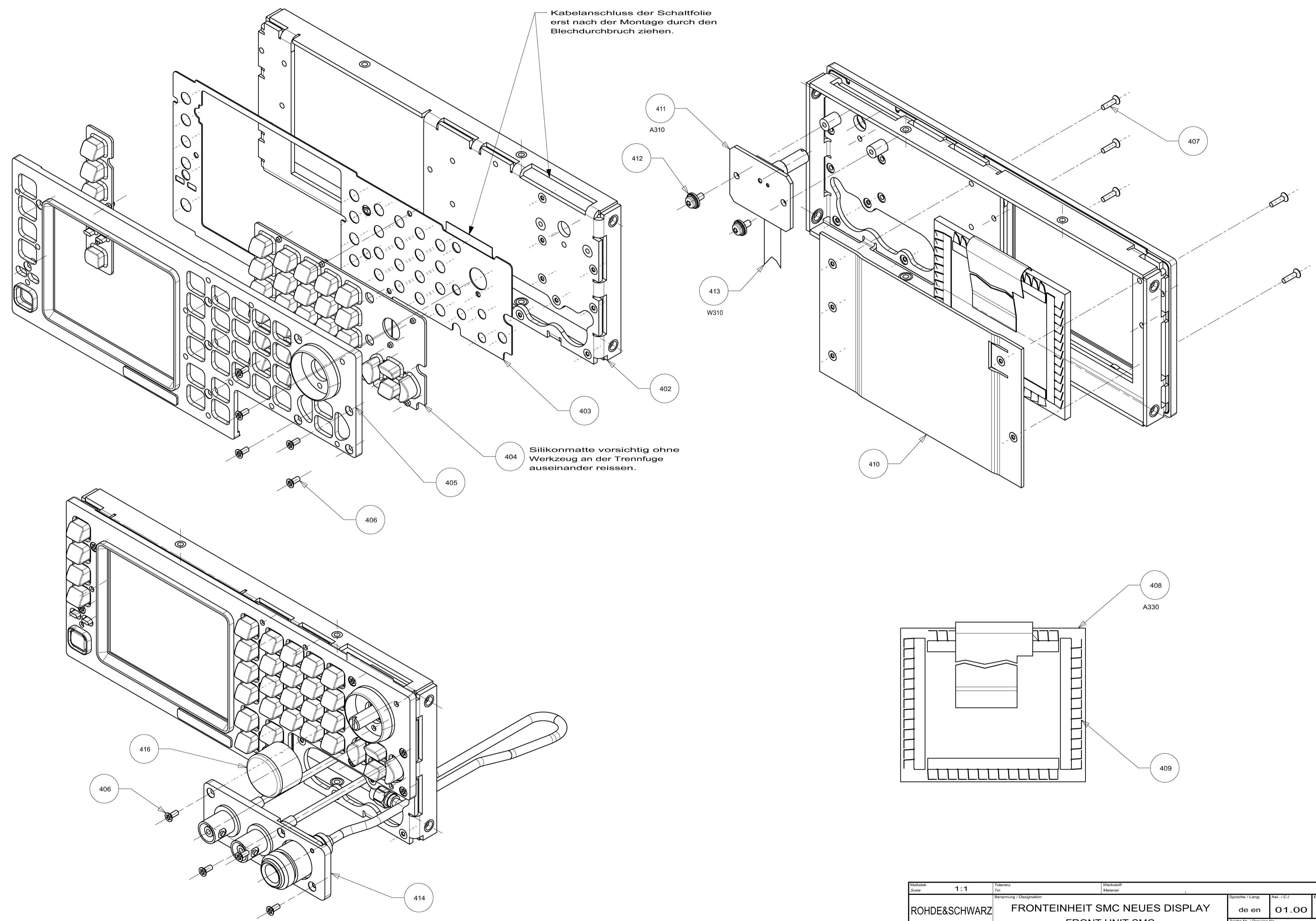

Maßstab Scale	1:1	Toleranz Tol.		Werkstoff Material		Sprache / Lang.	de en	Ver. / C.E.	01.00	Blatt / Sh.	1
ROHDE&SCHWARZ		FRONTEINHEIT SMC NEUES DISPLAY FRONT UNIT SMC				Zeichn.Nr. / Drawing No.		14 11.4802.01		D	
SMC	Datum Date	2010-03-10	Abteilung Dept.	3TPK	Name	Ke					

Für dieses Dokument behalten wir uns alle Rechte vor
 For this document all rights are reserved

Projektions-
 methode

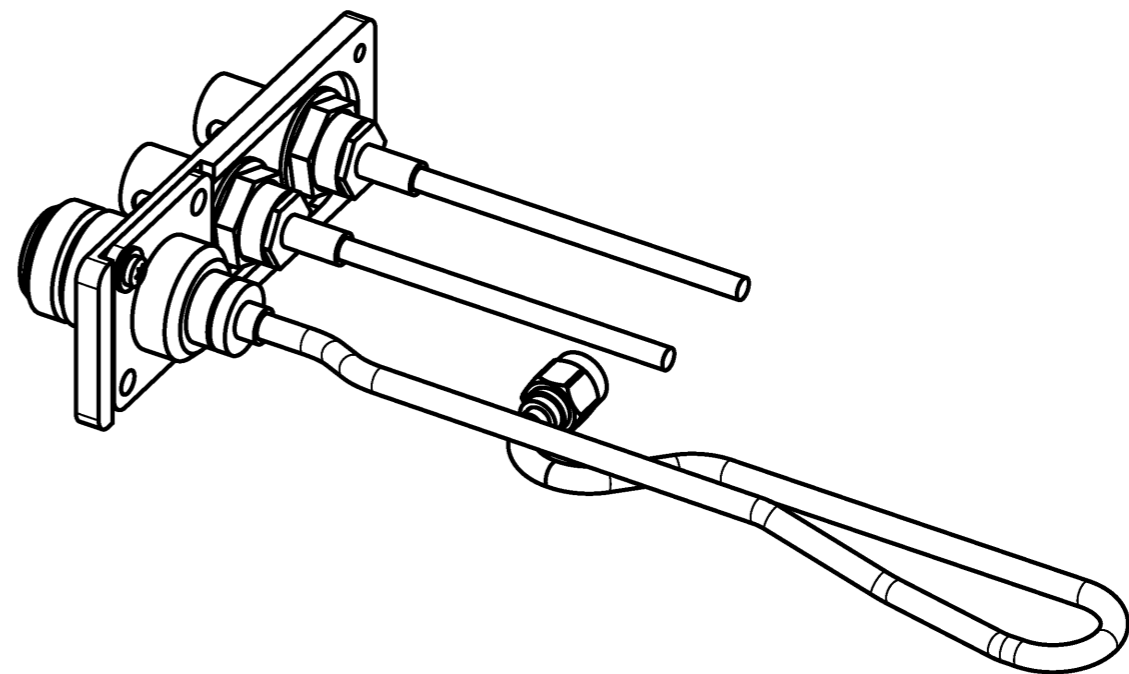
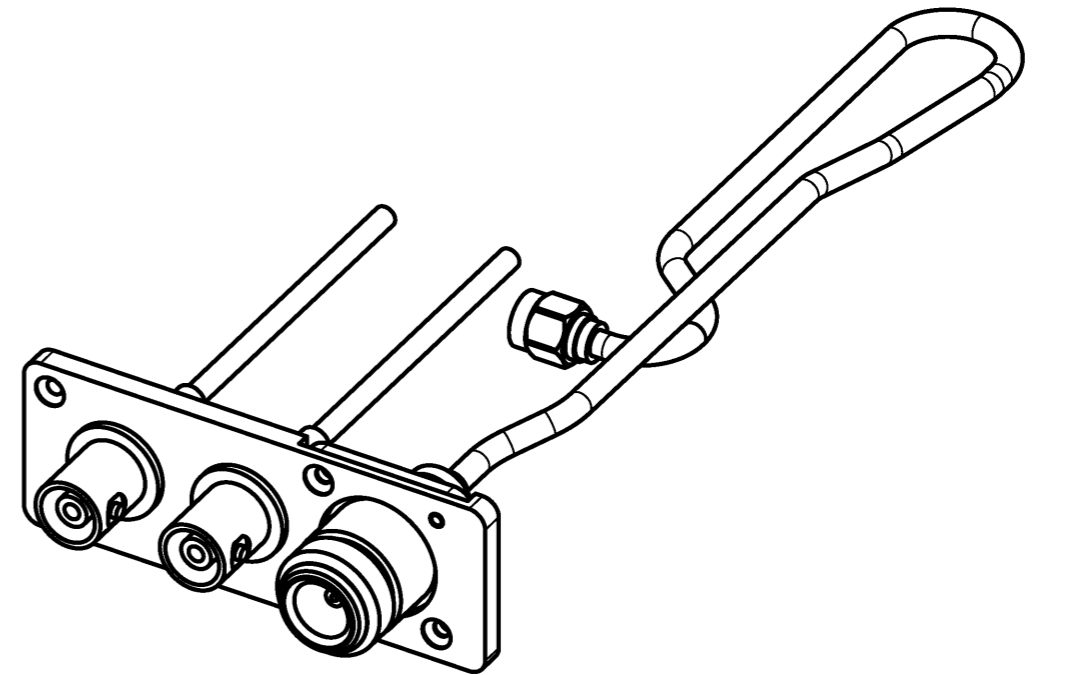
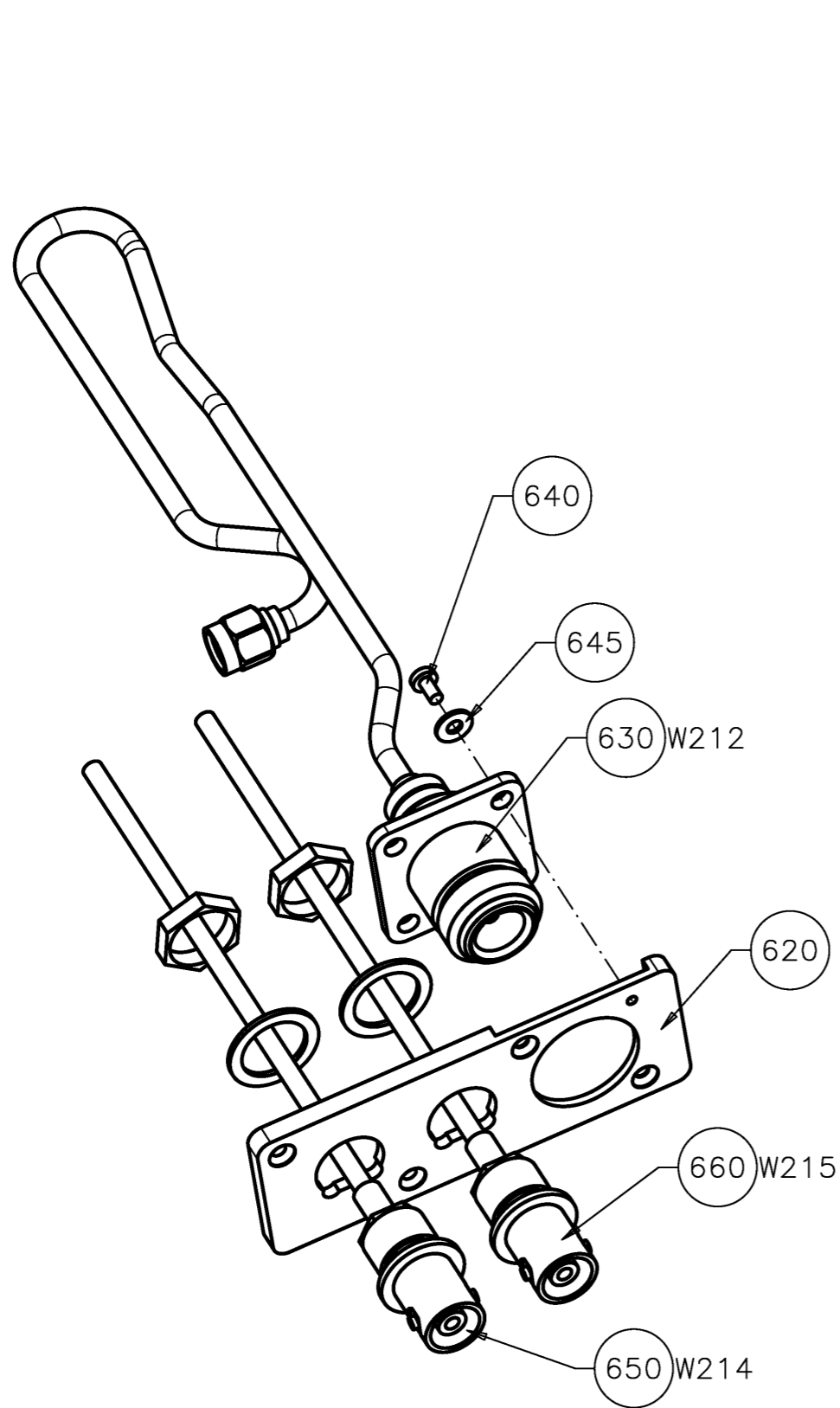
 Projection
 Method



Maßstab Scale	Toleranz Tol.	Werkstoff Material	Sprache / Lang. / Ael. / C.I.		Blatt / Sh.
ROHDE&SCHWARZ	Benennung / Designation FRONTANSCHLUSSPLATTE FRONT CONNECTOR PLATE		de en	03.00	1
Datum Date	2008-05-28	Abteilung Dept.	1ZKS	Name Name	Wb
Zeichn.Nr. / Drawing No.			1411.4748.00 D		